

Jicamarca Activities

July 2008 – June 2009



CEDAR 2009, Santa Fe, NM – June, 2009

Outline

- Radar development projects
 - Antenna beam switching, fourth transmitter, Multi-channel digital receivers
 - Software and databases
- Miscellaneous radar improvements
- Optical activities
- Operations and special experiments
- Visitors and trainee program

Antenna Beam Switching: ABS (1)

- Objective: Add electronic beam steering capabilities to JRO
- Main features
 - 3-bit control on each module
 - Few tenths of ms to change position (based on RF switches instead of pin-diodes)
- Current Milestones and dates
 - Proto-type testing: Underway
 - ¼ antenna switch units deployed: End of September 2009
 - Control system installed: En of May 2010

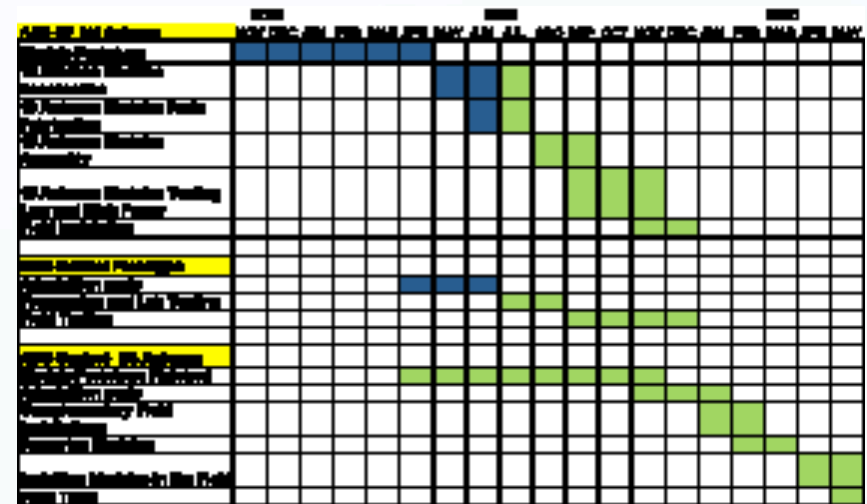

- Main Personnel
 - Project Manager: R. Yanque
 - RF Team Leader: D. Cordova
 - Control Team Leader: J. Quenta

Antenna Beam Switching: ABS (2)

Selected Bits	Cable length (m)	Att. (dB)
000	5	0.21
001	6	0.22
010	7	0.28
011	8	0.31
100	4.5	0.18
101	5.5	0.25
110	6.5	0.28
111	7.5	0.36

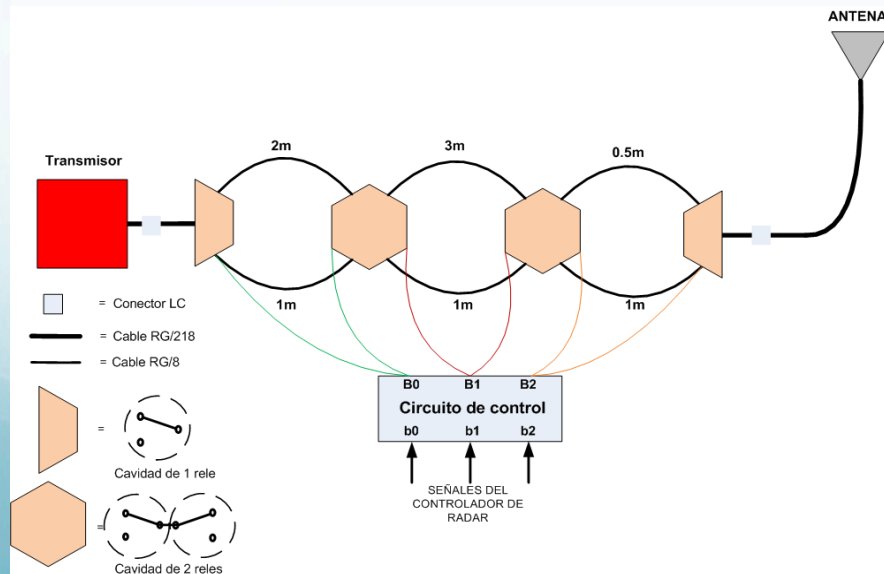

Jicamarca Acquisition Radar System: JARS (1)

- Objective: To develop an acquisition system based on home-made digital receivers
- Main features
 - At least 8 complex channels per computer.
 - At least 1 MHz sampling per channel in continuous mode.
- Current Milestones and dates
 - One channel testing: Done
 - 8 channel alpha testing: end of July
 - Delivered to operations: end of September

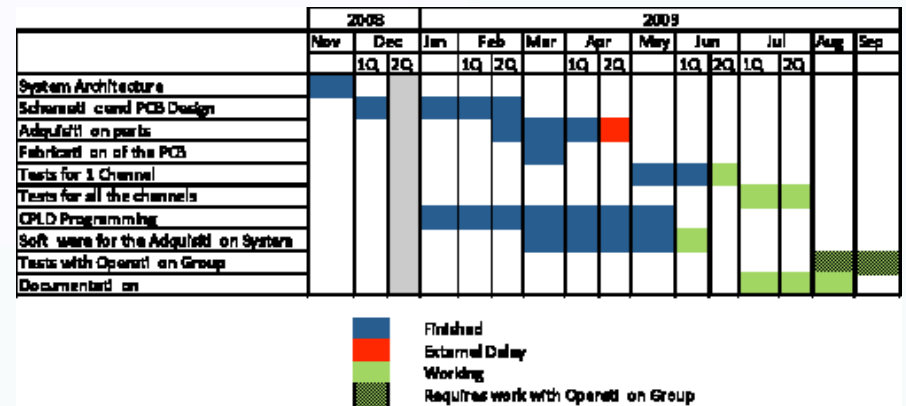

■ Main Personnel

- Project Manager: R. Yanque
- Team Leader: J. Alcantara
- Trainees:
 - R. Abad (Engineering Thesis)
 - M. Iñonan

Jicamarca Acquisition Radar System: JARS (2)

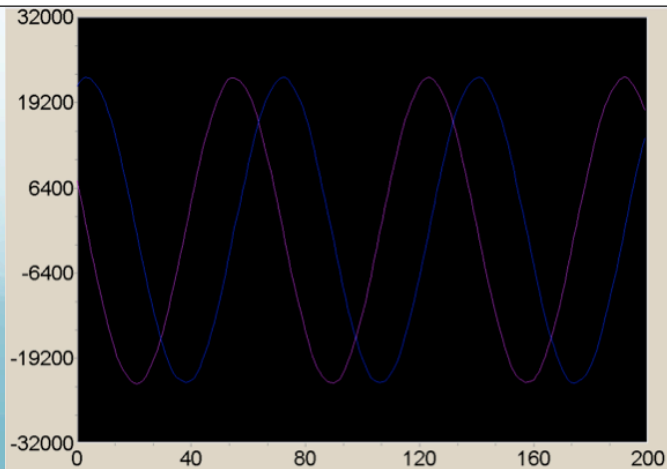
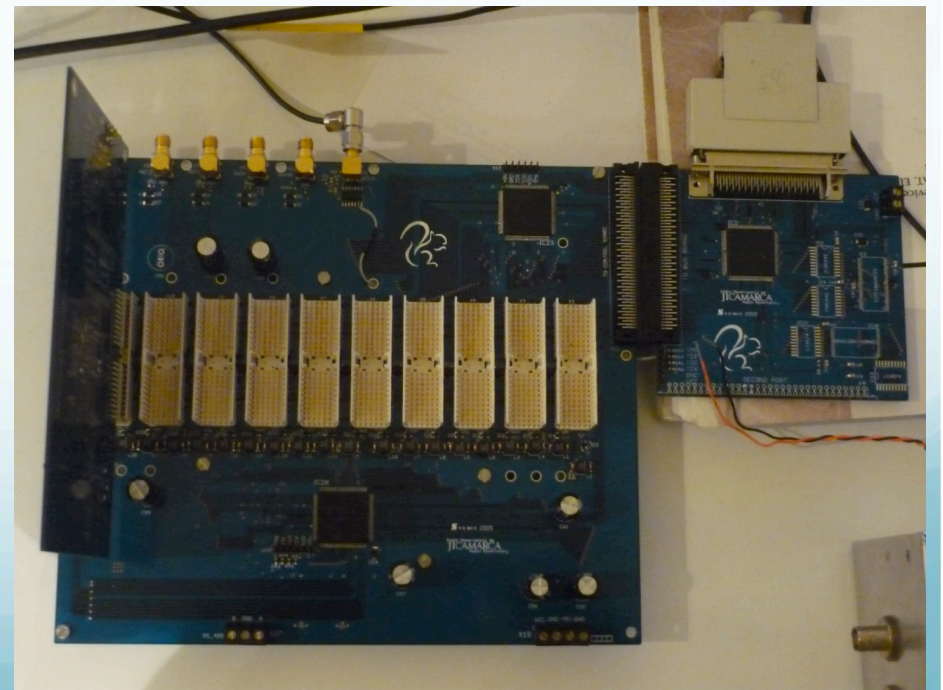
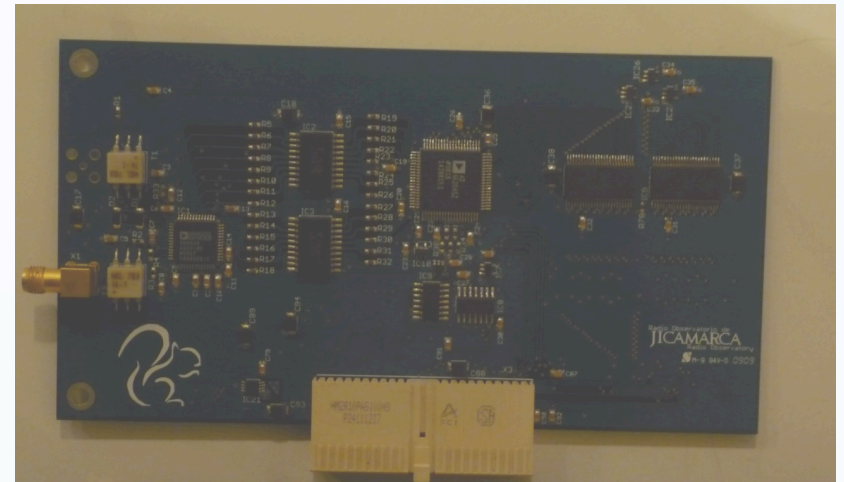
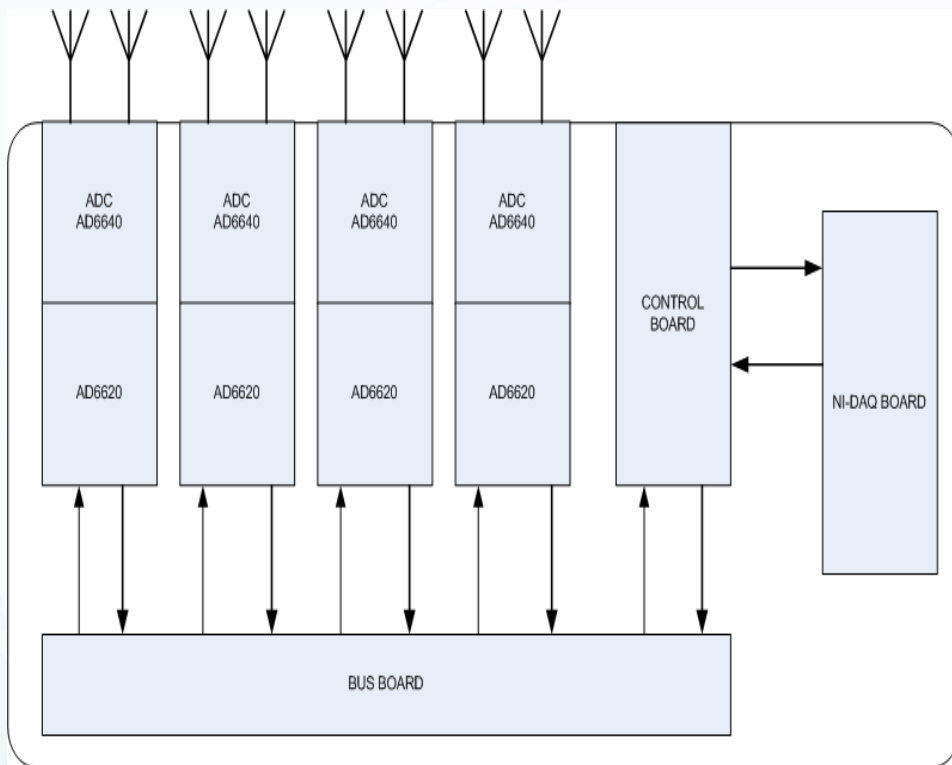

Software improvements

- Miscellaneous on-line monitoring, processing, and analysis GUIs for common modes (Drifts, JULIA, JASMET)
- Development of GUIs and web-based applications for non-radar data monitoring, processing, accessing (VIPIR, GPS, magnetometers, FPI Arequipa, meteorological stations)
- Development of “JRO Backup Manager” for rawdata/spectra archival
- Unification of radar databases around Madrigal with the help of Bill Rideout (see poster by M. Urcos et al.)

JRO Databases before Bill's visit

Main JRO database

Instrument / Mode	CEDAR	Madrigal	JRO Web	JRO Internal *	Other
ISR Oblique	Ne, Te, Ti, %	Ne, Te, Ti, %	Ne, Te, Ti, %	Rawdata	[Cornell] [JRO mirror]
ISR Perpendicular	Drifts	Drifts	Drifts	Rawdata	[U. Illinois] [JRO mirror]
JULIA			RTIs	Spectra	[Cornell] [JRO mirror]
Bistatic	E Ne	E Ne	E Ne	Spectra	
150-Km	Drifts	Drifts	Drifts	Spectra	
Radar imaging				Cross Spectra	Cornell
Meteor Heads				Rawdata	

* Request data by emailing to database@jro.igp.gob.pe

Other JRO Instruments

Instrument / Mode	JRO Web	JRO Internal *	Other
Digisonde	Ionograms	Ionograms	U.M. Lowell
JASMET			
Magnetometers	ΔH ExB drifts(ΔH)	1 min	[Kyoto U.] [INTERMAGNET]

* Request data by emailing to database@jro.igp.gob.pe

Other databases

Instrument / Mode	JRO Web	JRO Internal *	Other
Arequipa FPI	F-region winds and temperature	Images	
GPS Data	Rx links	Rinex, LB2	LISN
Kp-Index	(link)		
Jicamarca Wind Profiler	Wind maps	Spectra	
Northern Peru Wind Profilers	[Consensus, windmap] [online]	Processed data, ACFs	

* Request data by emailing to database@jro.igp.gob.pe

JRO Databases after Bill's visit

JRO Madrigal data access

Instrument:

Jicamarca IS Radar 1994-2009

Experiment:

All experiments

Year:

2009

Month:

May

May 2009

Sun	Mon	Tue	Wed	Thu	Fri	Sat
26	27	28	29	30	01	02
03	04	05	06	07	08	09
10	11	12	13	14	15	16
17	18	19	20	21	22	23
24	25	26	27	28	29	30
31	01	02	03	04	05	06

Simple Madrigal data access - select option...

Selected Instrument:

- Jicamarca IS Radar

Selected Experiment:

Drifts

Selected dates:

- 2009-05-13

plot Data

print Data

download File

view Header&Catalog

Choose parameter to plot:

lon velocity in direction 5 (perp north)

Select y axis:

Altitude

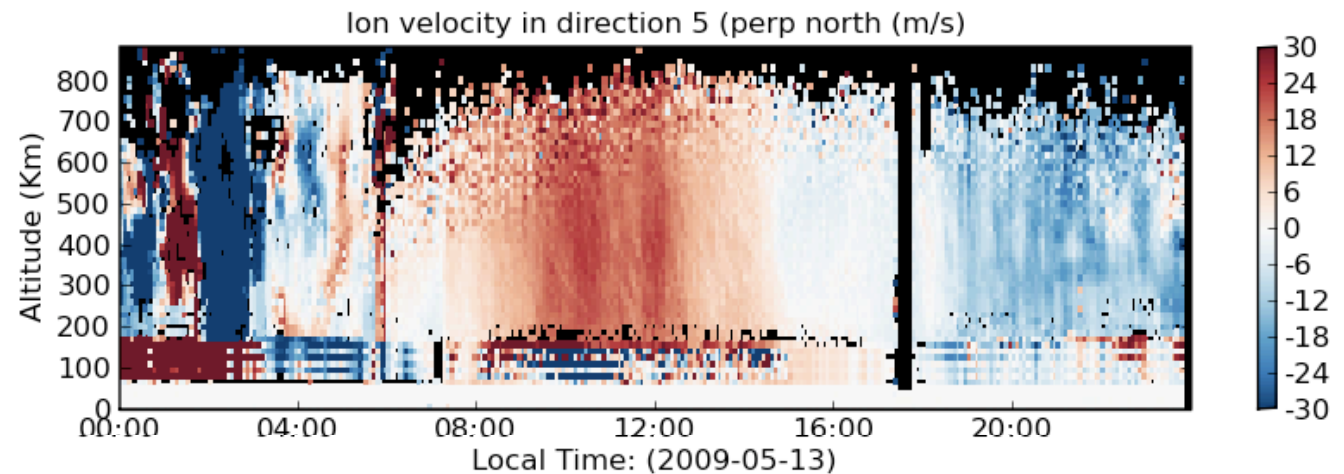

Advanced Filters

Time:	00 - 24	<input type="radio"/> Time-Average
Altitude:	0.0 - 885.0	<input type="radio"/> Height-Average
ColorMap Range:	-30.0 - 30.0	<input checked="" type="radio"/> Disabled-Average

Apply

Reset

[see poster by J. Urcos]

Miscellaneous Improvements

- Improvements to the existing high-power T/R switch
 - Temperature/humidity control
 - Use of low power passive T/R switch as limiters
- Increased averaged Transmitter power (one power supply for each driver + Optimized resistors selection for protection)
- Larger capacity RAID system (12 TB)
- Improve main antenna performance (repairs of dipoles, better preventive maintenance, replacement of cables/connectors)

Improvements on high-power TRs

WITH PASSIVE TRs for protection

NATIONAL Cross Spectra - Date: 23-Jun-2009 09:01:

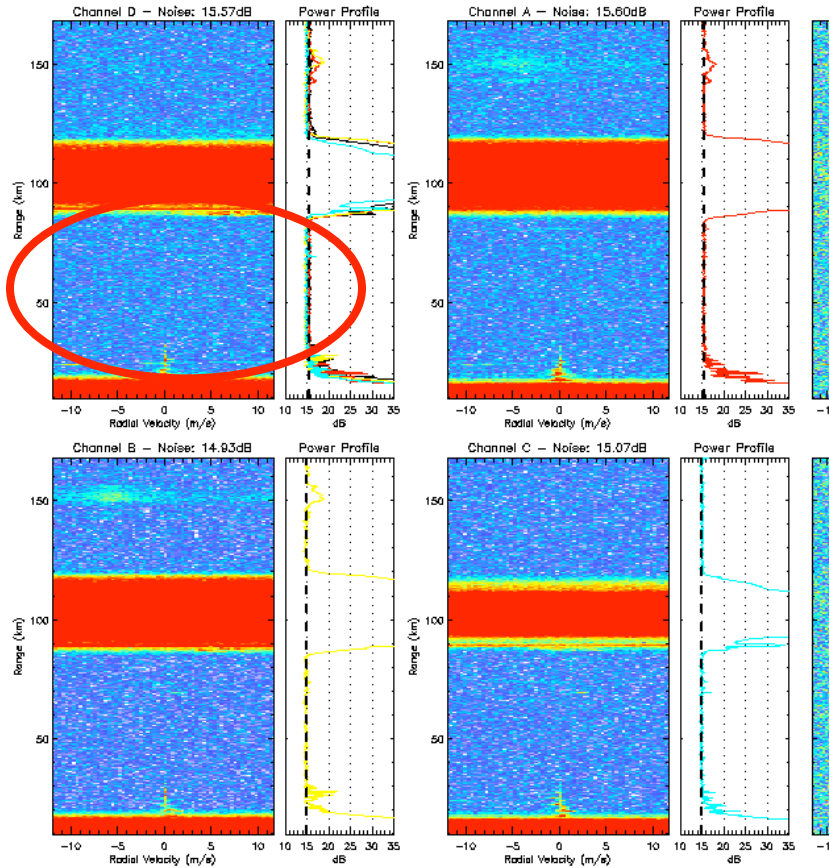

WITHOUT PASSIVE TRs for protection

NATIONAL Self Spectra - Date: 22-Jun-2007 17:59:01

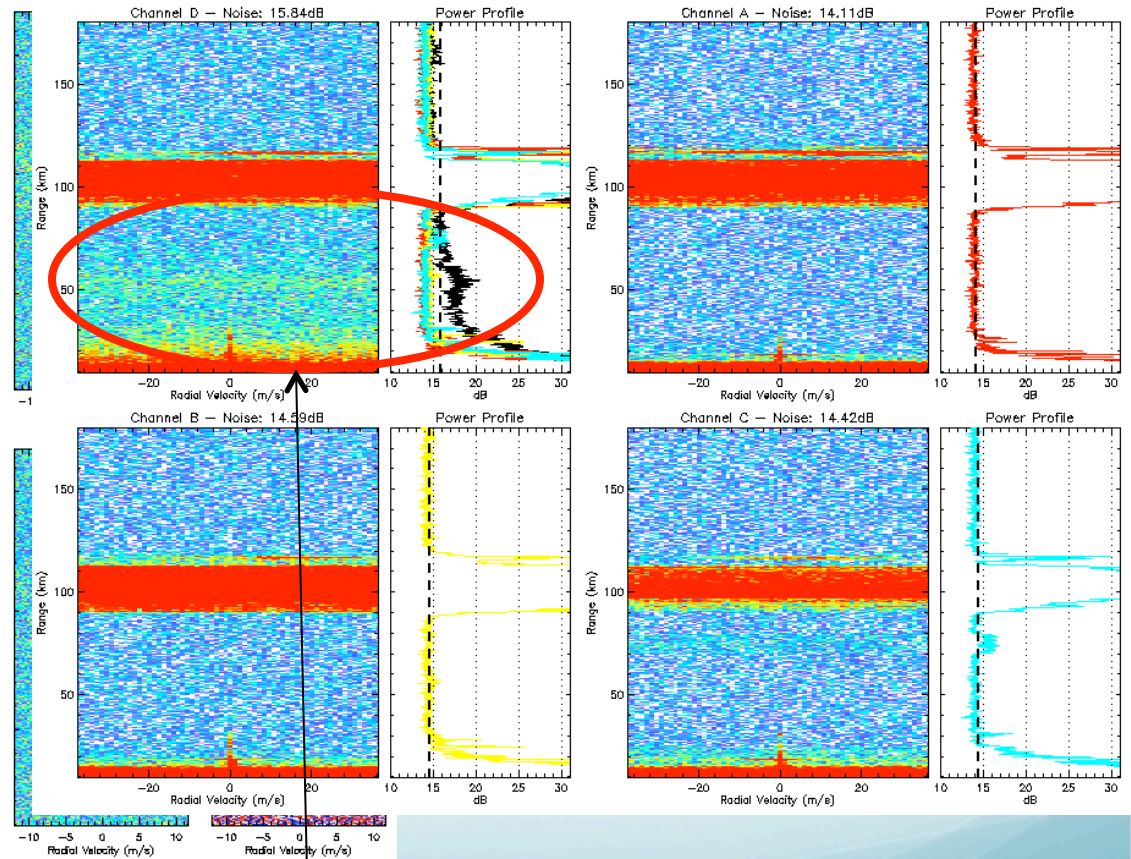

Tungsten TR fluctuations

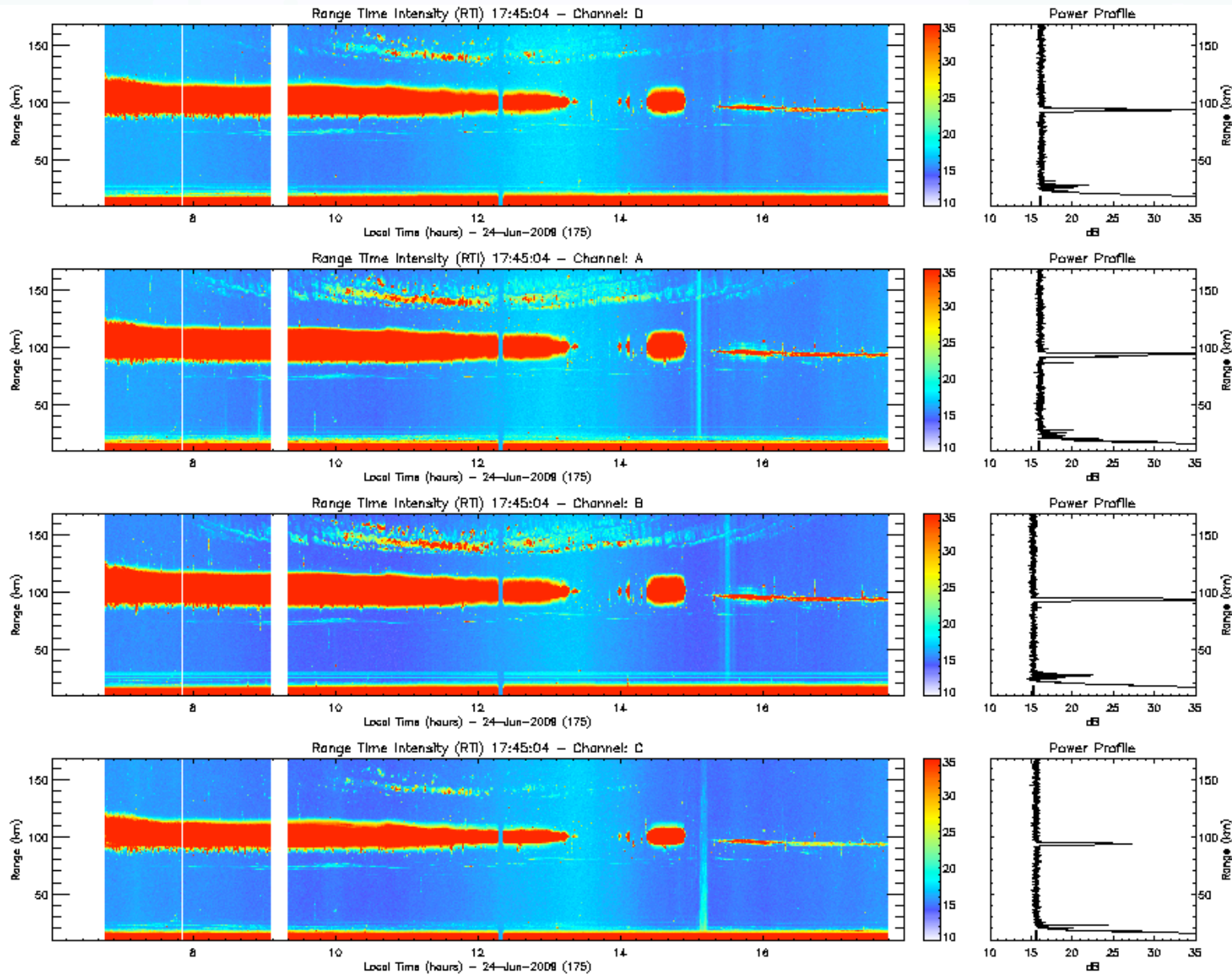

Solar min. ExB drift measurements

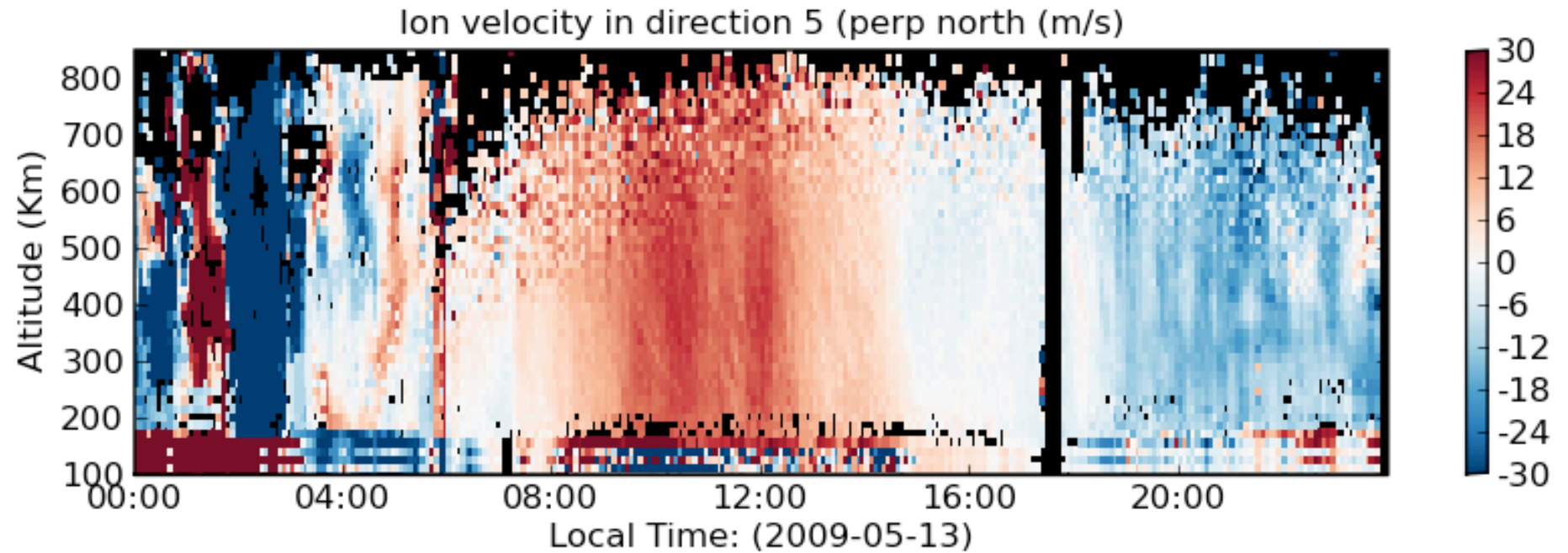

Sky noise temperature measurements

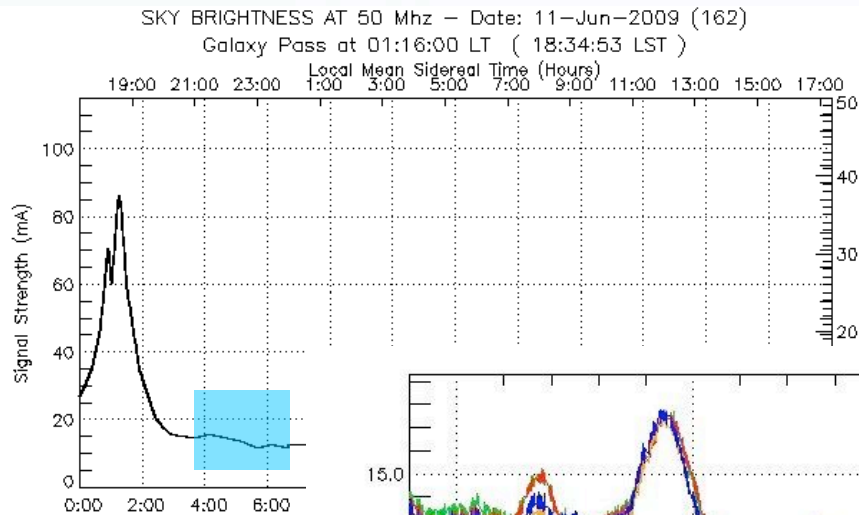

Small changes (~ 0.1 mA) associated to antenna gain changes.

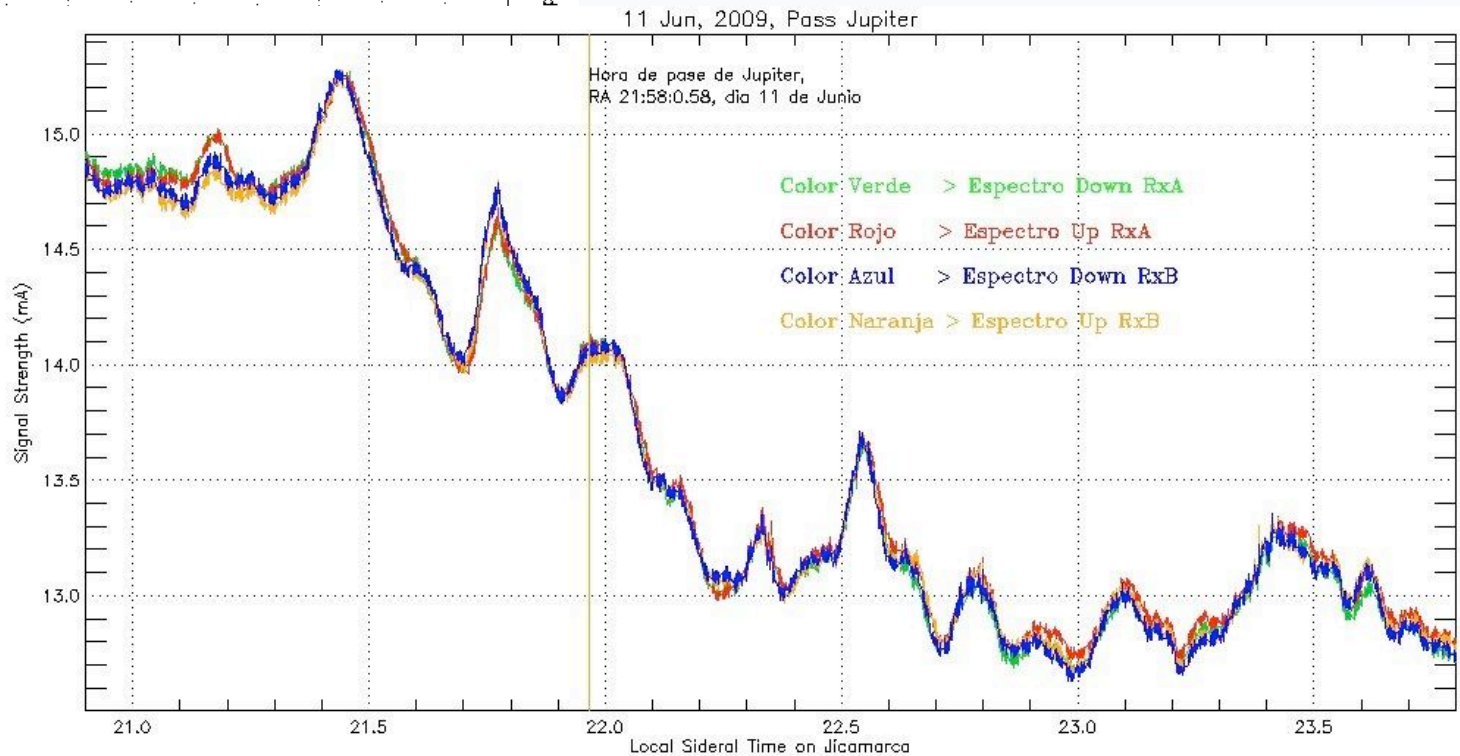

[courtesy of R. Woodman]

Multi-beam ISR: Oblique + Perpendicular

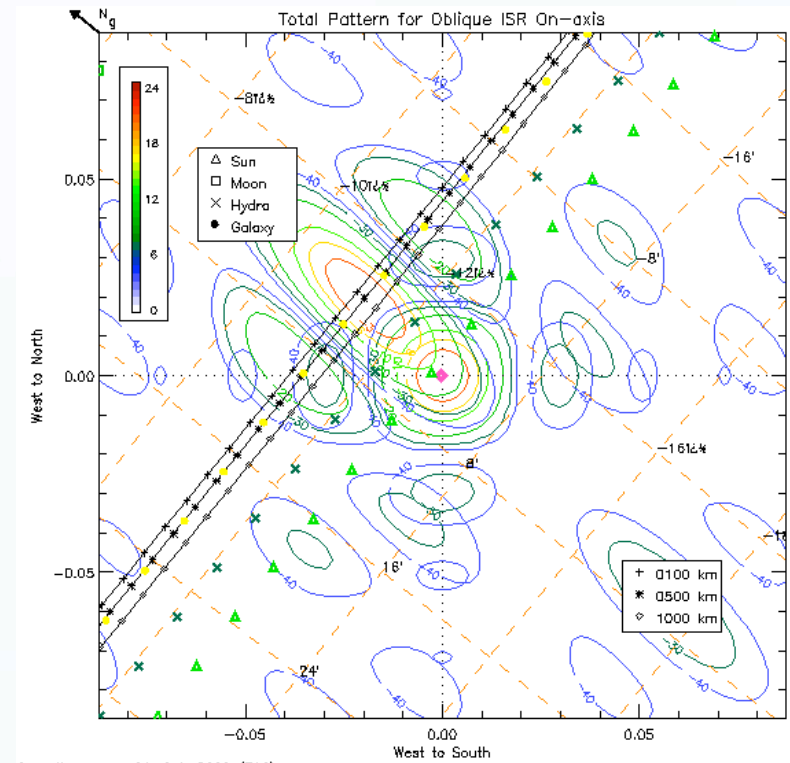
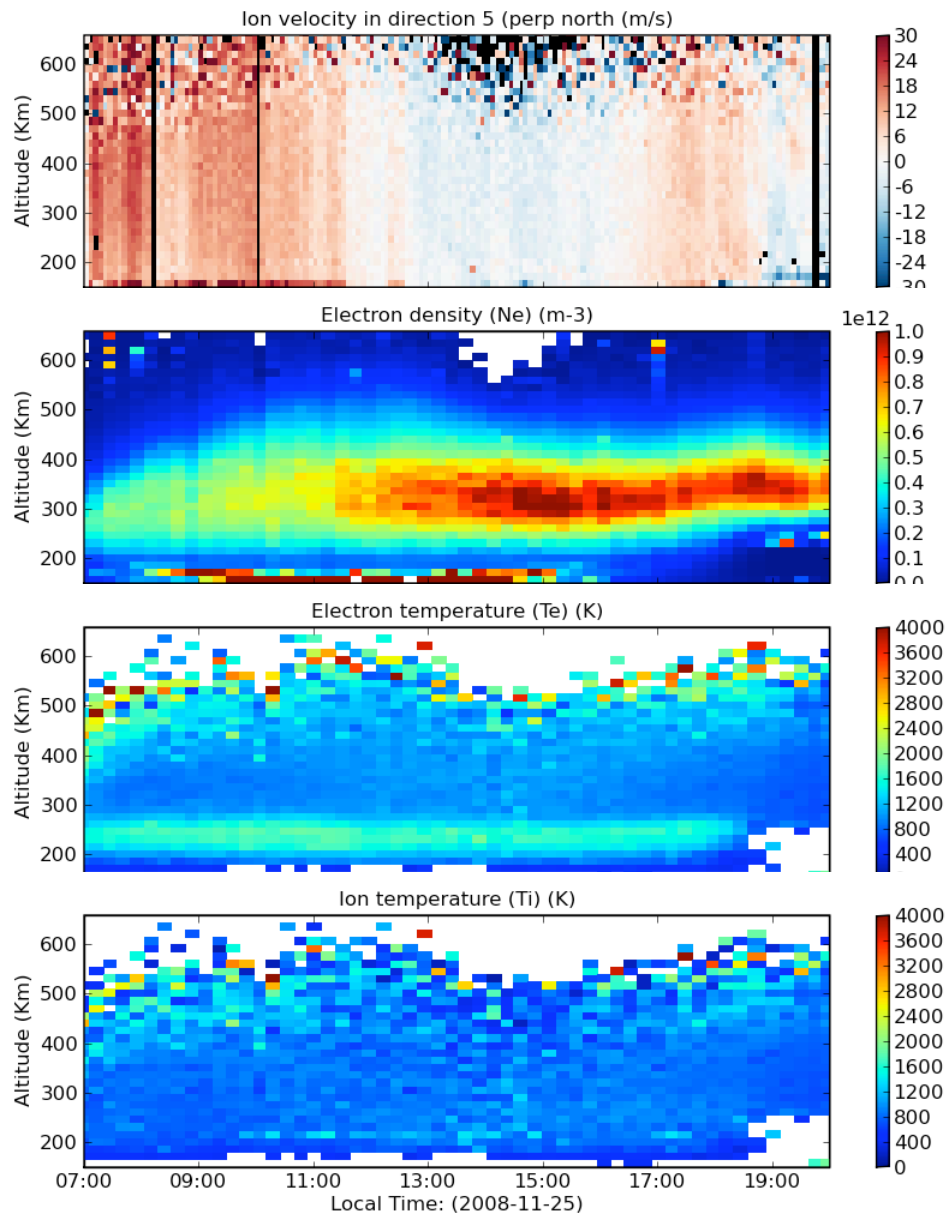

Oblique: Two txs, two polarizations, NS quarters

Perpendicular: One tx, two polarizations, EW quarters

Optical Activities

- FPI at Arequipa (see J. Meriwether's talk)
- SOFDI at Huancayo (see. A. Gerrard's report)
- Optics at JRO
 - Where: MeriHill
 - What:
 - mini FPI (J. Meriwether/Clemson)
 - Imager (G. Swenson/UIUC)
 - When: This summer



Pointer 11 57'19.3



Status of MerriHill Observatory

- Electricity: 3 kW line already installed
- Building: under construction
- FPI equipment: on its way
- Imager equipment: end of summer
- Internet: Wireless link
- First light: Expected by the end of July



Radar Operations 2008-2009

	2008							2009					
Exp	Jun	Jul	Aug	Sep	Oct	Nov	Dec	Jan	Feb	Mar	Apr	May	Total
ISR	148:40	177:05	0:00	31:15	110:50	43:35	0:00	187:15	59:50	82:10	27:25	50:20	918:25
Julia	262:25	468:05	478:40	473:40	238:20	627:50	534:40	212:05	303:35	439:15	452:25	583:50	5074:50
Otros	5:10	6:25	136:30	3:35	0:25	0:00	23:15	0:00	0:00	0:00	11:40	0:20	187:20
	416:15	651:35	615:10	508:30	349:35	671:25	557:55	399:20	363:25	521:25	491:30	634:30	6180:35

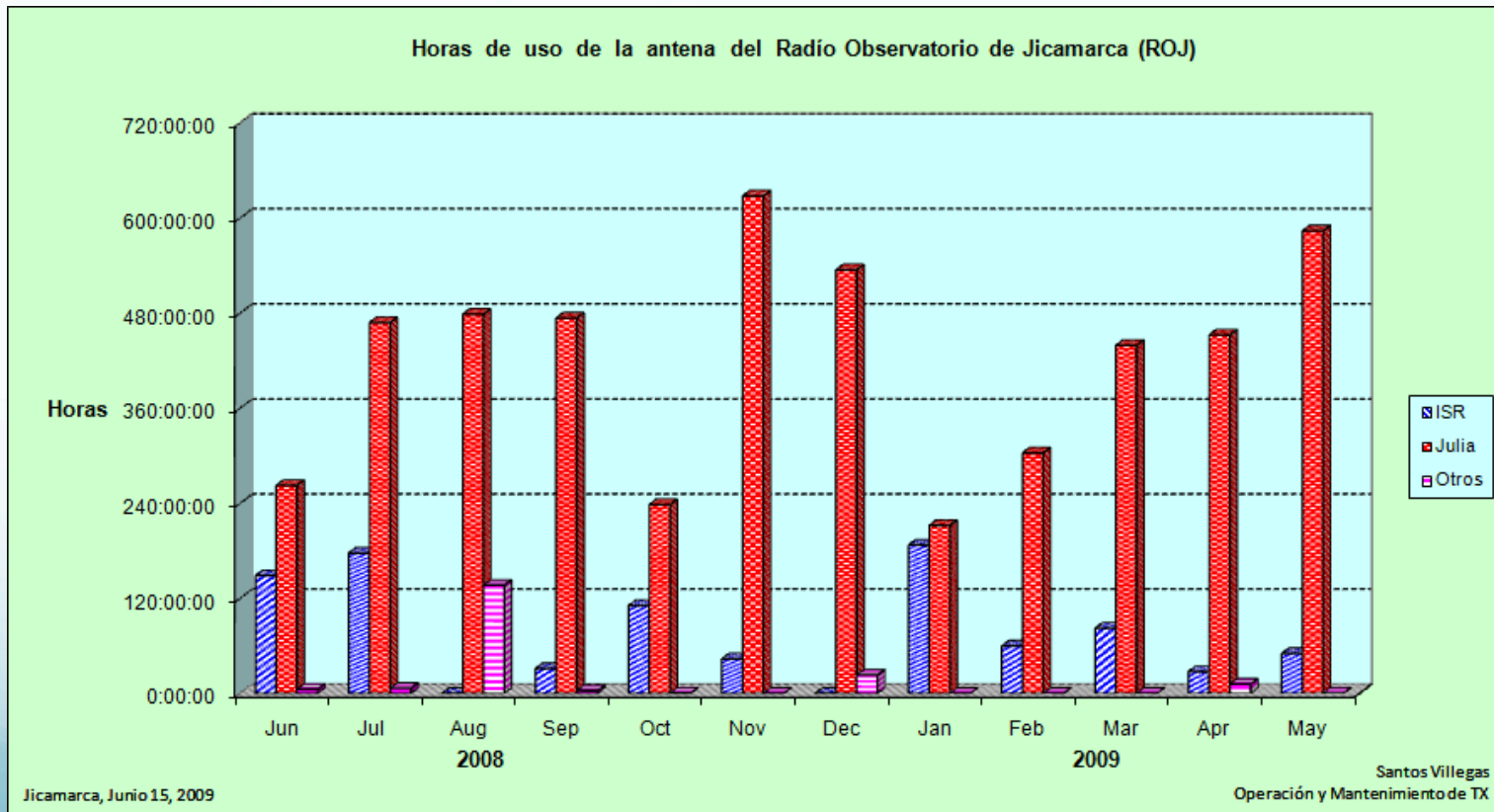

(ISR includes C/NOFS support for: 68 hours, 5 campaigns, 15 days)

2008-2009 Experiments

User	Institution	Time	Topic
C/NOFS	Various	Many	CALVAL
D. Hysell/J.Chau	Cornell/JRO	Feb 2009	ESF: Radar Imaging + C/NOFS
C. La Hoz	Tromso U.	Apr 2009	150-km 3D Imaging
J. Chau/F. Galindo	JRO	Dec 2008	Geminids meteor shower
B. Fejer	USU	Apr 2009	High-altitude drifts (solar min)
E. Kudeki/G. Lehmacher	UIUC/ Clemson	Jan 2009	MST-ISR2
L. Waldrop/S. Gonzalez	UIUC/ Arecibo	Apr 2009	Topside ISR modes +C/NOFS
M. Milla/E. Kudeki	UIUC	Jan 2009	Valley region (VIPIR+ISR)
W. Swartz/D. Farley	Cornell	Mar 2009	EEJ+150-km Aspect Sensitivity
R. Hedden/D. Hysell	Cornell	Mar 2009	ESF Aspect Sensitivity
J. Chau/D. Hysell	JRO/Cornell	Nov 2008	Oblique + Perp ISR

(in addition to World days, JULIA, JASMET)

Student Projects: 2008-2009

Student	Advisor	Degree/Inst.	Topic
Marco Milla	E. Kudeki	Ph.D./UIUC	Perpendicular to B ISR Parameters
M. Olsen	B. Fejer	Ph.D./USU	Strat Warming and ExB drifts
P. Reyes	E. Kudeki	Ph.D./UIUC	Mesosphere/150-km/Perp. B
E. Bass	M. Oppenheim	Ph.D./BU	Multi-meteor echo studies and masses
A. Malhorta (*)	J. Mathews	Ph.D./PSU	Meteors, sporadic E
N. Chapagain	B. Fejer	Ph.D./USU	JULIA ESF
L. Guo (*)	G. Lehmacher	Ph.D./Clemson	“Ignorosphere” parameters
R. Ilma	M. Kelley	Ph.D./Cornell	Various
G. Sugar	M. Oppenheim	B.S./BU	LT winds from meteor echoes
R. Varney (*)	M. Kelley	Ph.D./Cornell	D-region and meteor smoke
N. Yoza	J. Chau	B.S./PUCP	EEJ Communications
N. Mateo (*)	J. Morton	Ph.D./Miami U.	TEC (GPS vs. ISR)
N. Slowey (*)	M. Oppenheim	B.S./BU	Meteor head and non-specular echoes
B. Tuysuz (*)	J. Urbina	Ph.D./PSU	Passive radar (meteors, EEJ)

Jicamarca International Research Experience Program



Nicholas Matteo

Mathematics

Miami University at Ohio

Burak Tuysuz

ECE

Penn State University

Nicholas Slowey

Physics & Astronomy

Boston University