

# Radar calibration of mesospheric and ionospheric echoes based on the incoherent scatter and magneto-ionic propagation theories (MST-ISR 2 campaign)

Marco Milla <sup>(1)</sup>, Erhan Kudeki <sup>(2)</sup>, Pablo Reyes <sup>(2)</sup> & Jorge Chau <sup>(1)</sup>

(1) Radio Observatorio de Jicamarca, Instituto Geofísico del Perú

(2) ECE department, University of Illinois at Urbana-Champaign

November 29, 2010



URSI PERÚ - II Encuentro Nacional de Radio Científicos e Investigadores Afines 2010

Pontificia Universidad Católica del Perú



Since Dec 2004, we have been sampling the F-region incoherent scatter returns in Jicamarca MST experiments in order to calibrate the data for absolute radar cross-section (RCS) measurements.

## OUTLINE:

- 1) Describe how we do the calibration, and
- 2) Show examples with data collected during the 11-day run that took place in Jan 2009.

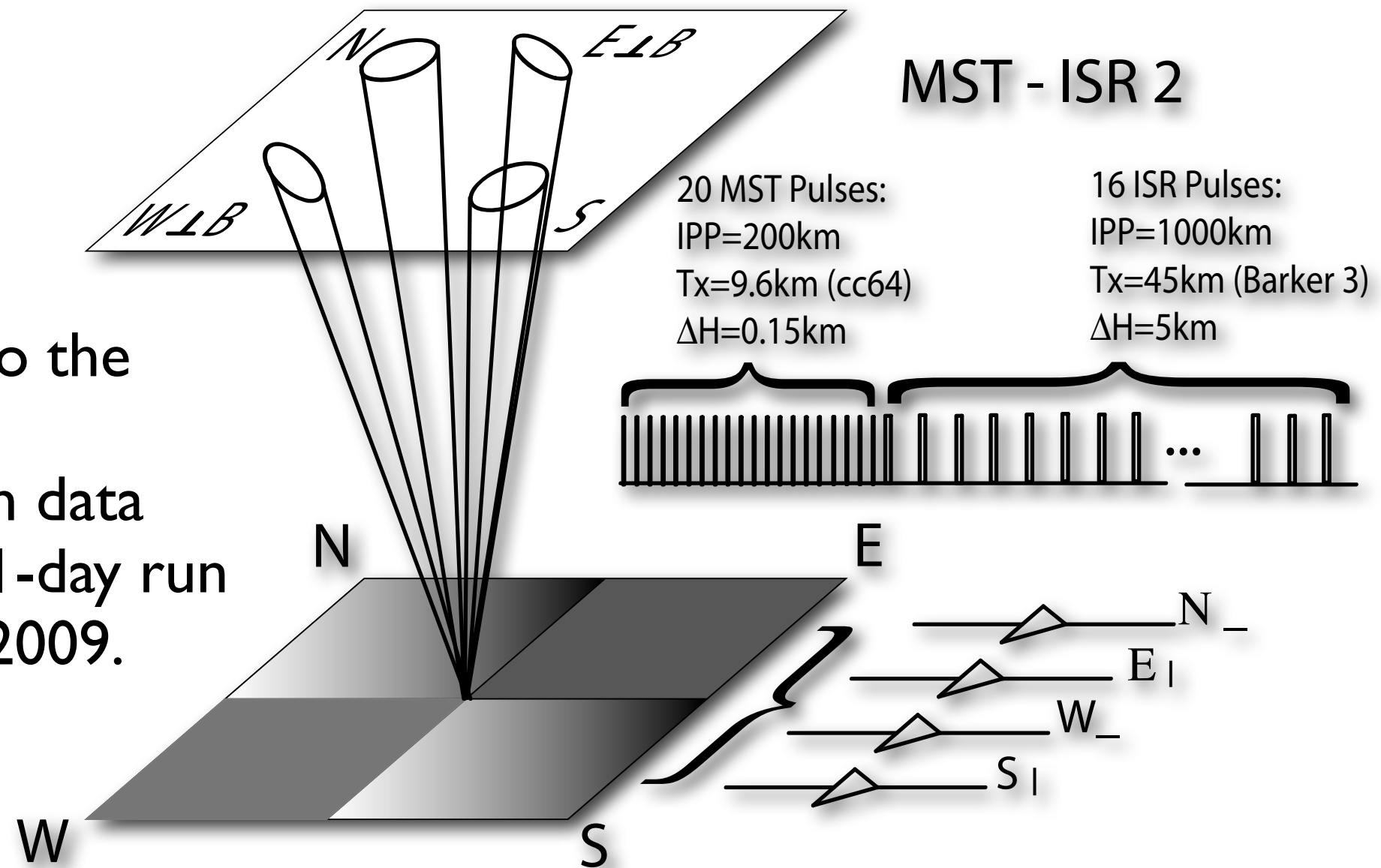

Absolute RCS measurements are possible by comparing the MST-scattered power with F-region ISR power because ISR power is proportional to the electron density that can be independently measured (or guessed).

$$\langle |V_r(t)|^2 \rangle = \frac{\kappa}{r^2} \int d\Omega G_{tx} G_{rx} \tilde{\sigma}$$

$$\tilde{\sigma} = 4\pi r_e^2 N_e f\left(\frac{T_e}{T_i}\right)$$

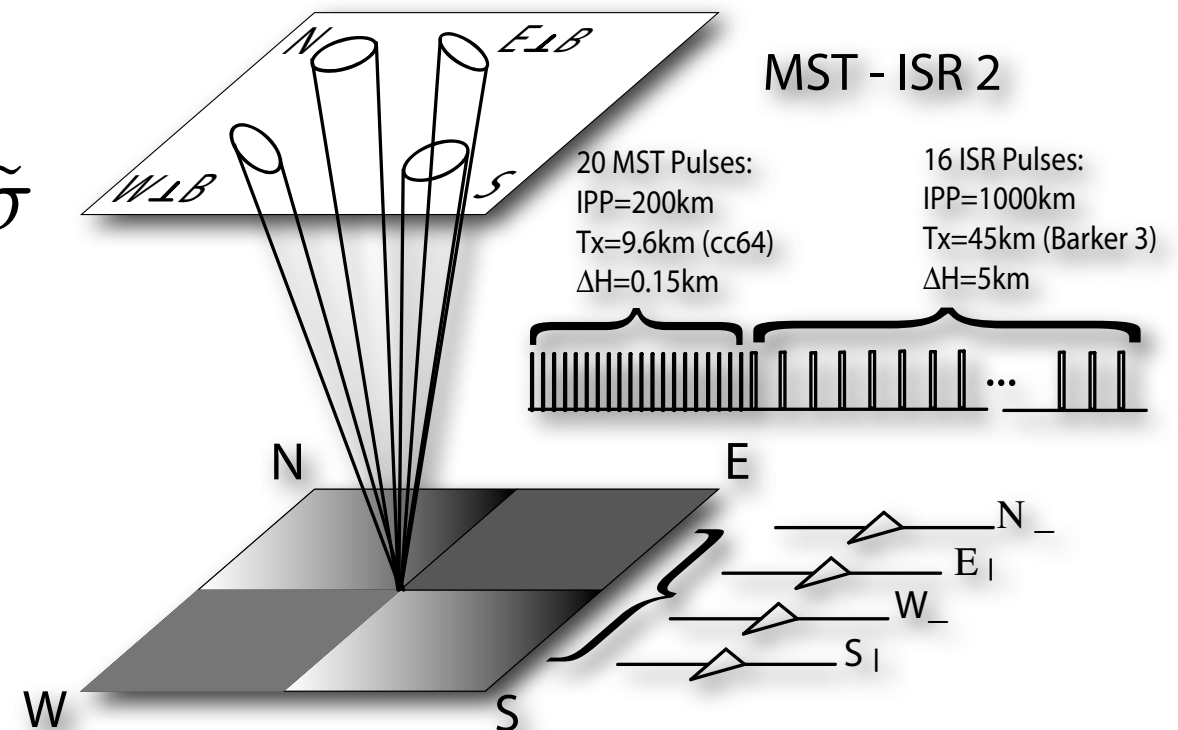

But there are complications:

- 1) The proportionality factor depends on  $T_e/T_i$
- 2) Unless a magneto-ionic “normal mode” is used for tx and rx, there are **magneto-ionic power distortions** --- wiggles --- to account for.



# Jicamarca antenna array has 2 polarizations, each polarization is divided in quarters:

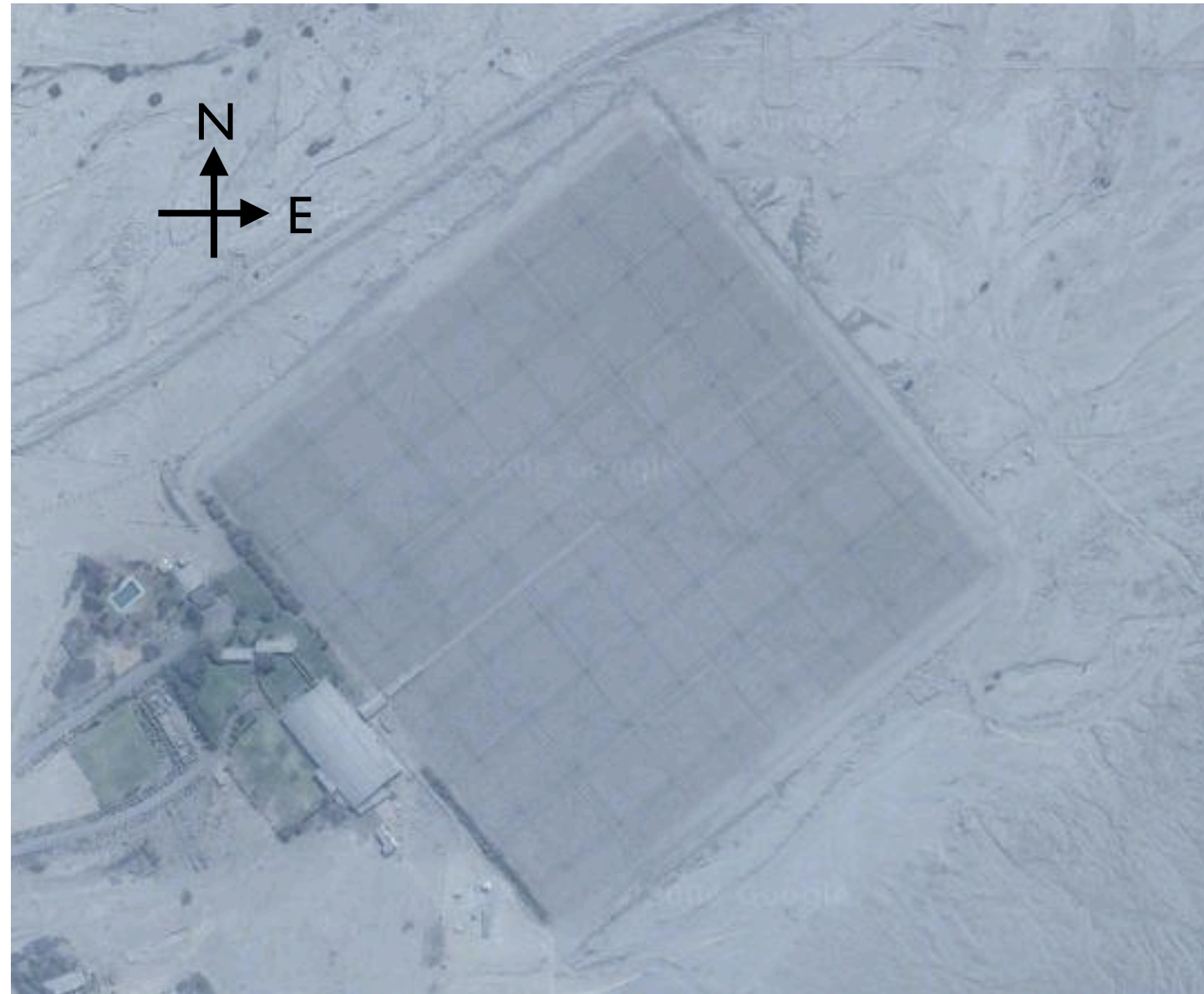

# Jicamarca antenna array has 2 polarizations, each polarization is divided in quarters:

x-pol (D-pol) excites and detects the North and West beams

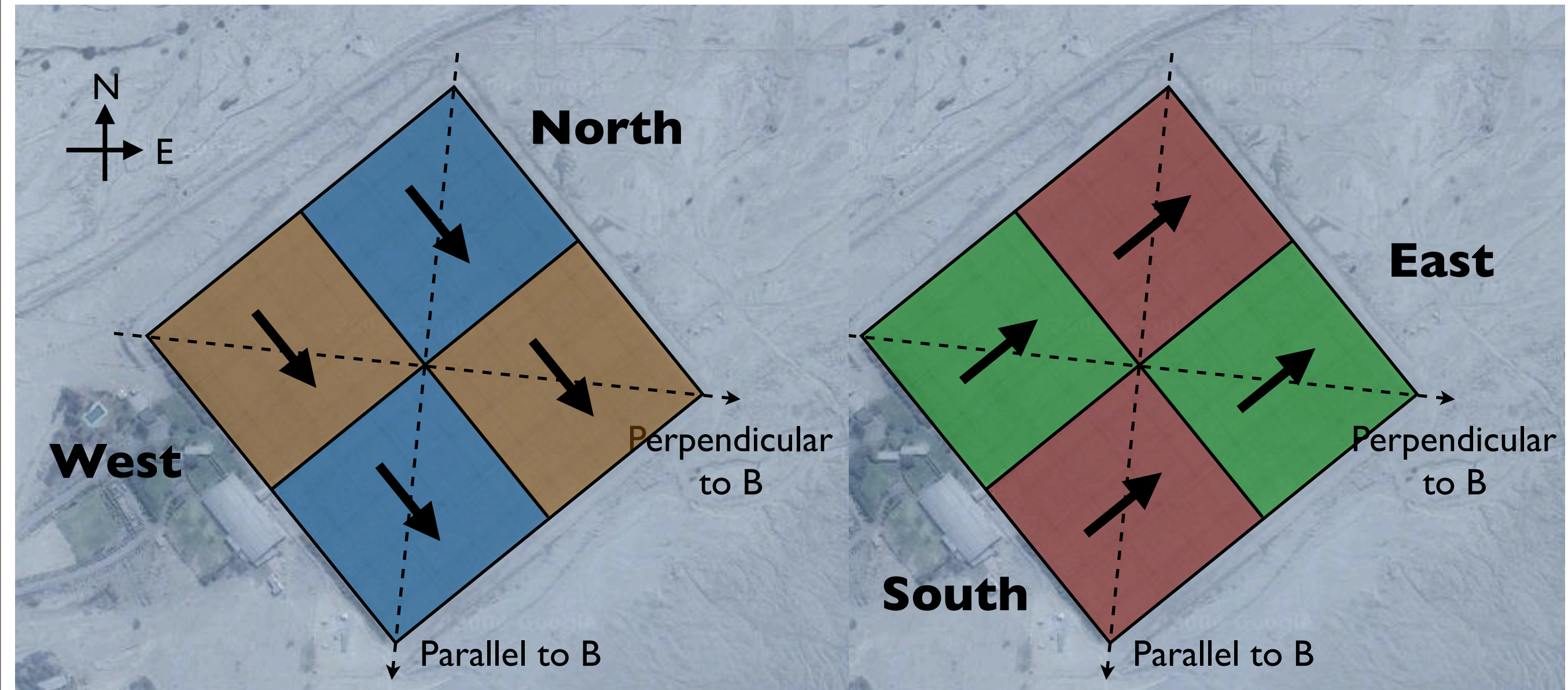

y-pol (U-pol) is used for East and South beams





# 4 beams are synthesized using both polarizations

North beam (D-pol)

D2W = 75.6 dB – ABS = 3084

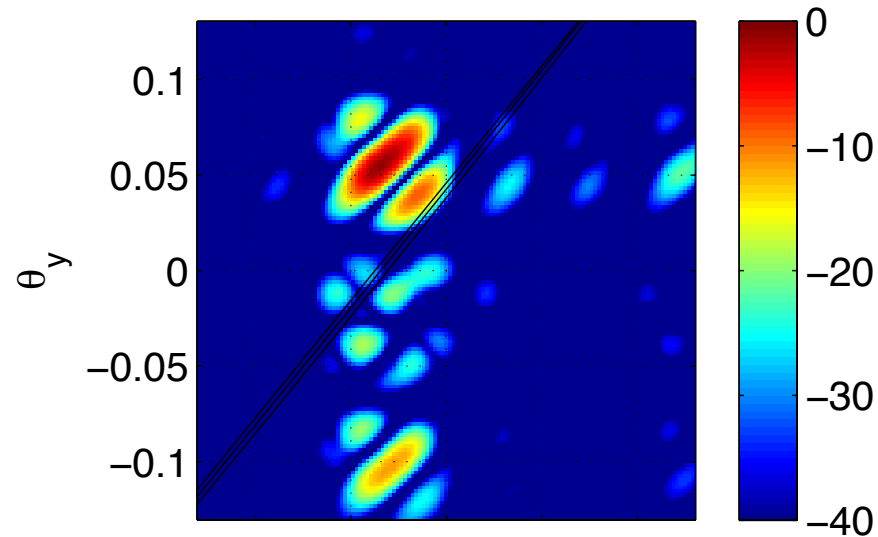

East beam (U-pol)

D2W = 73.4 dB – ABS = 2152

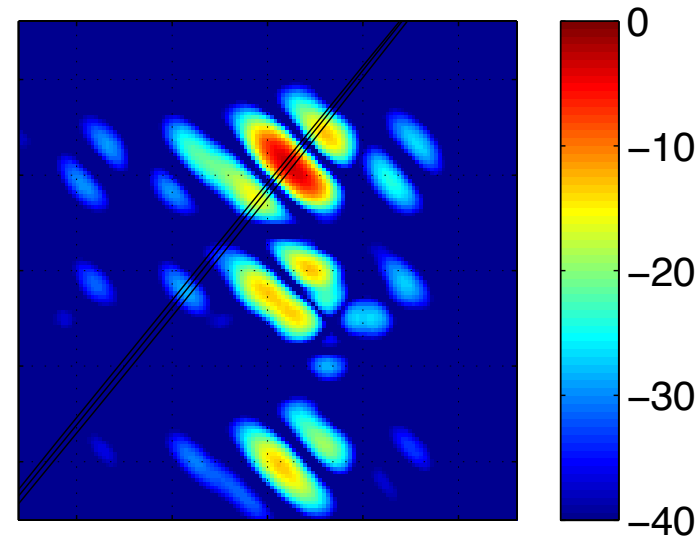

West beam (D-pol)

D2W = 74.1 dB – ABS = 2423

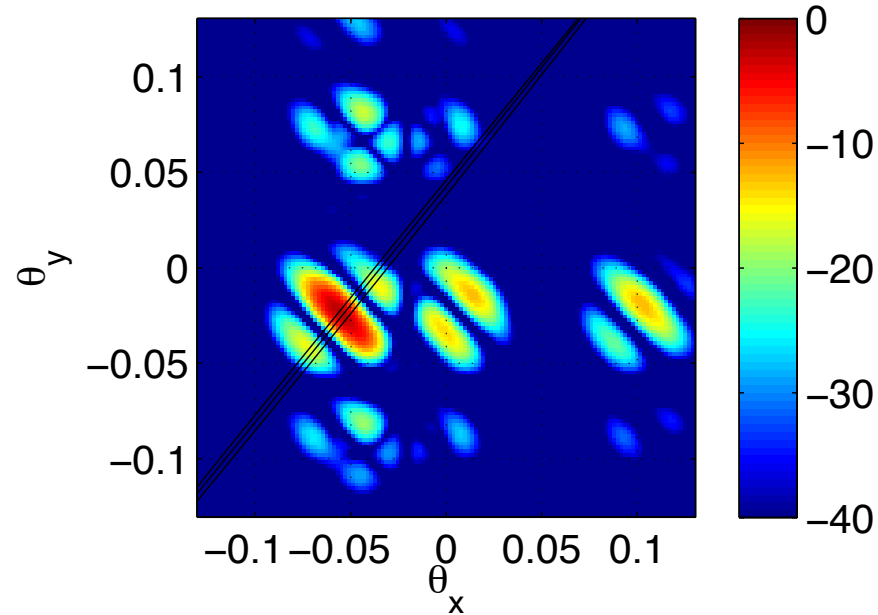

South beam (U-pol)

D2W = 76.7 dB – ABS = 3711

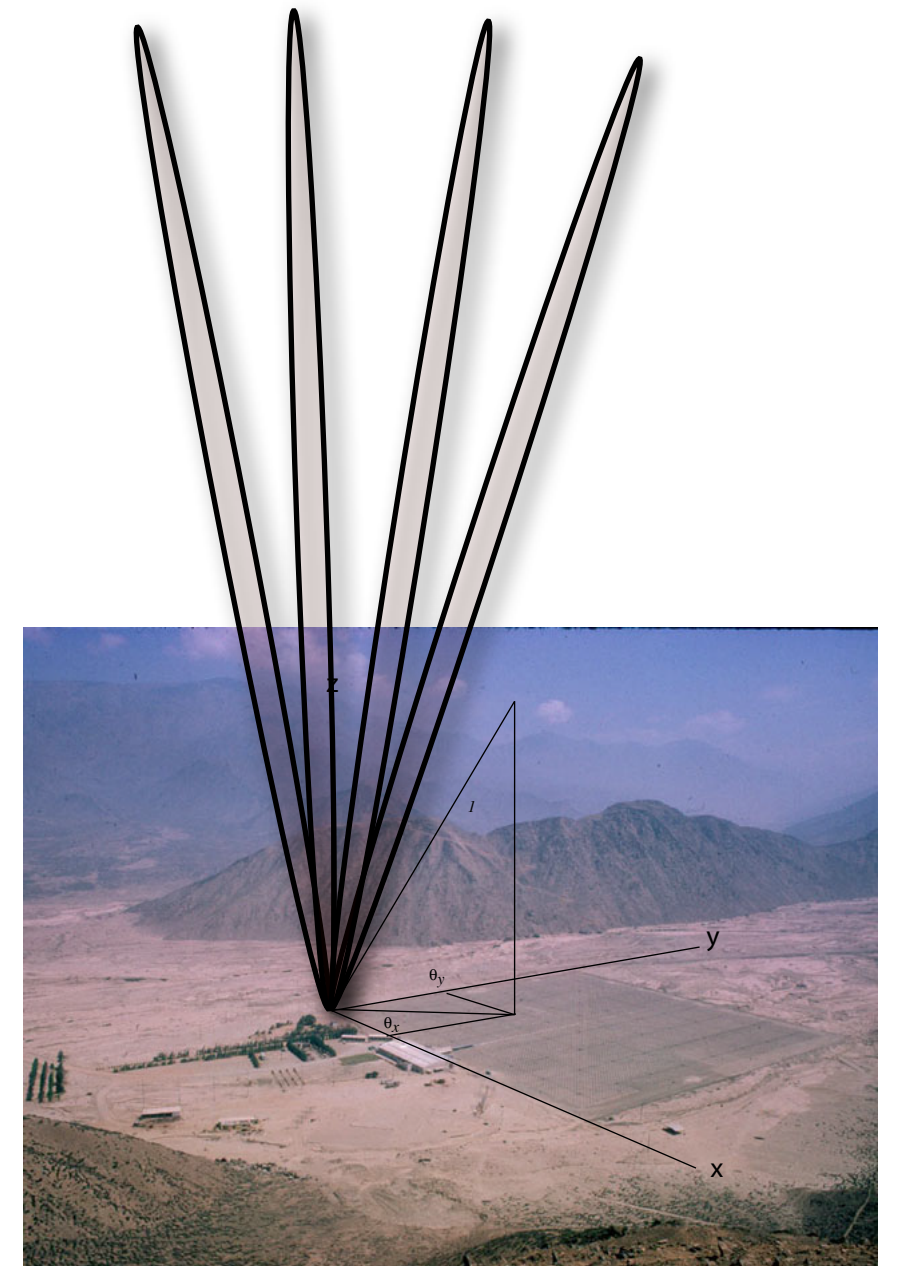
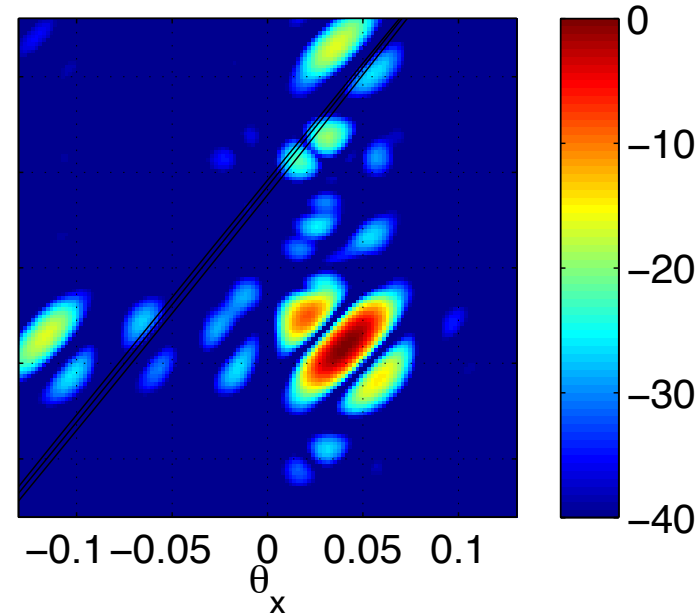

Magneto-ionic distortions cross-couple the beams because different beams have different aspect angles to **B**

**Basic idea used in the experiment:** In an ionosphere with **Ne and Te/Ti profiles** shown on the left, a north-south beam scan would produce a **total backscatter power map** shown on the right, with the sharp enhancement (“dagger”) in the direction where the radar beam is perpendicular to B:

$$P_s \propto \frac{N_e}{1 + T_e/T_i} \quad \text{away from perp to B, otherwise } P_s \propto N_e \eta, \quad \eta =$$

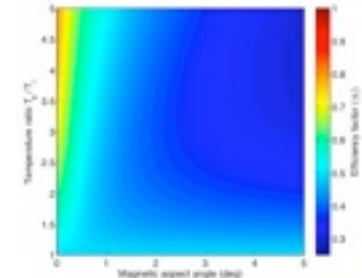

A scan like this cannot be done at JRO having fixed beams, but the effect has been observed and fully modeled at ALTAIR to estimate Ne and Te/Ti parameters from power scan data.

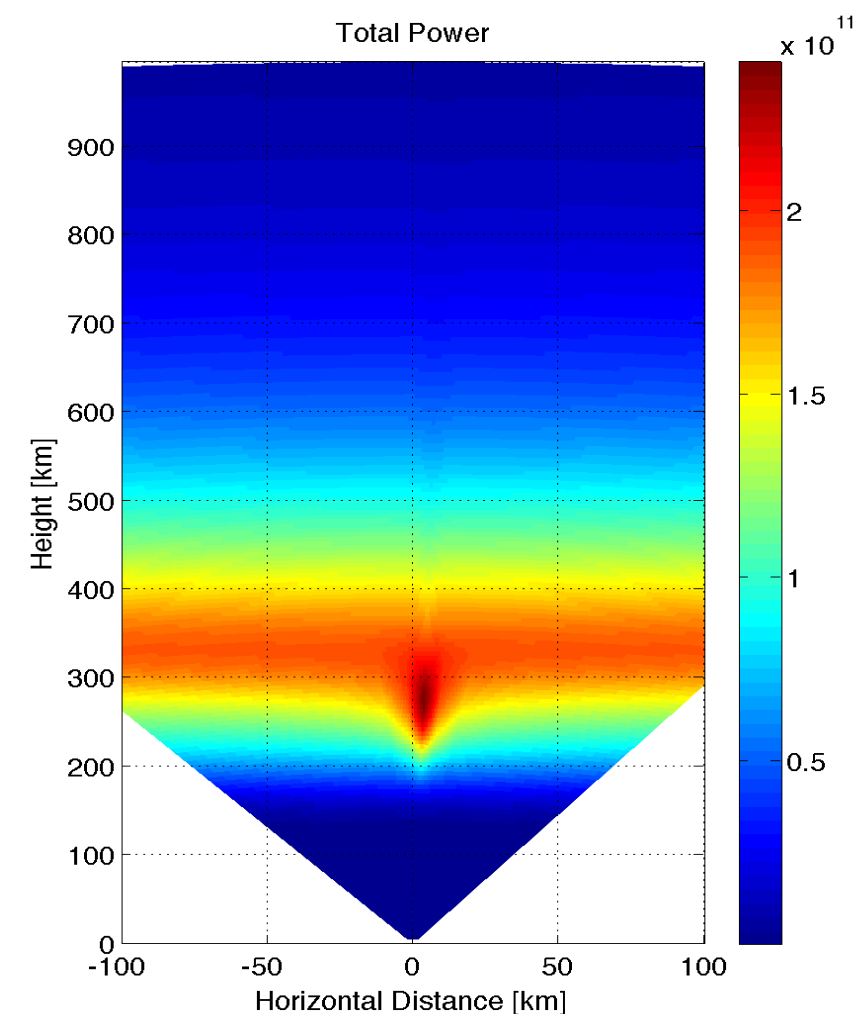
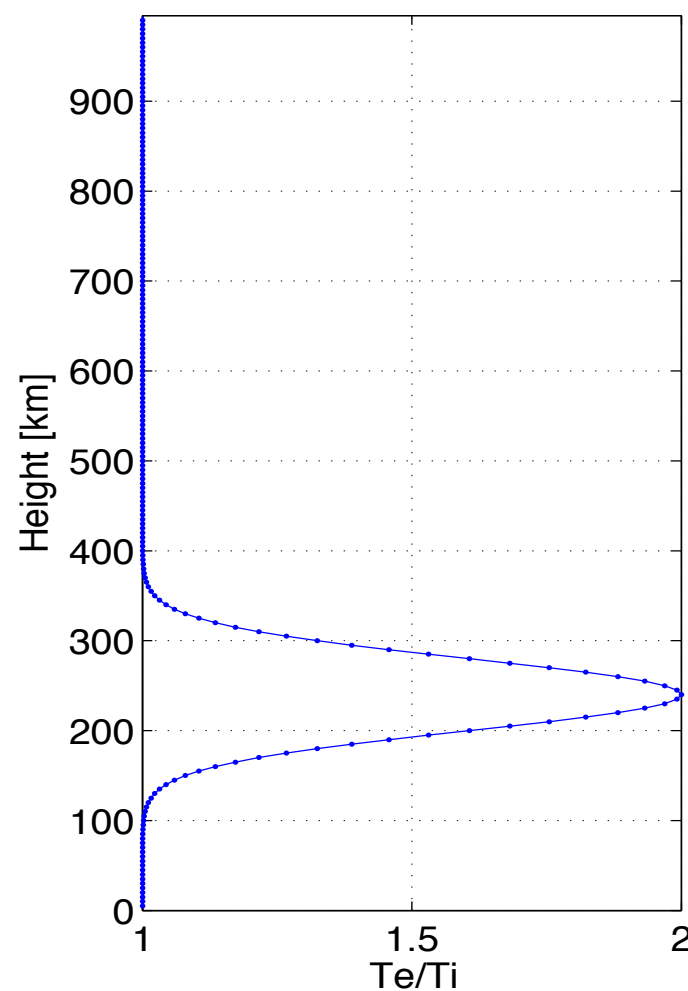
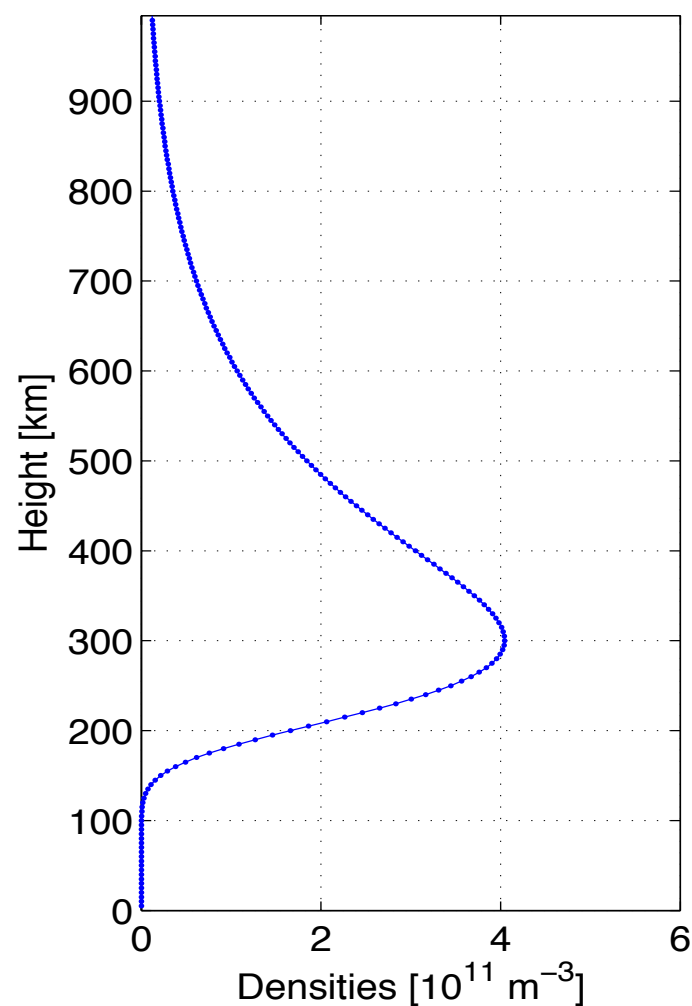

# Simulated total power and JRO beams used in the experiment:

At JRO, operating at 50 MHz, MI-effects are important, and thus both “co-pol” and “x-pol” components of the scattered power need to be modeled and processed to make Ne and Te/Ti estimation.

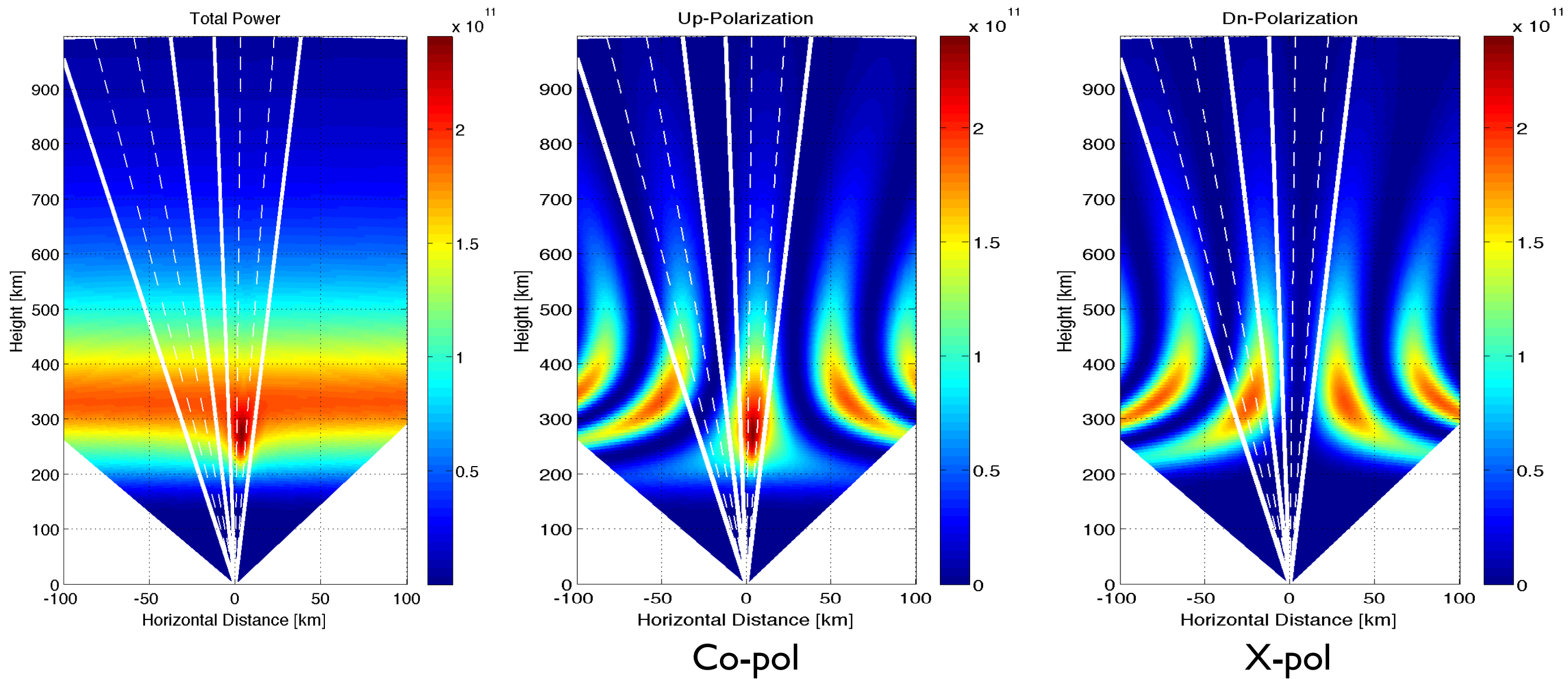
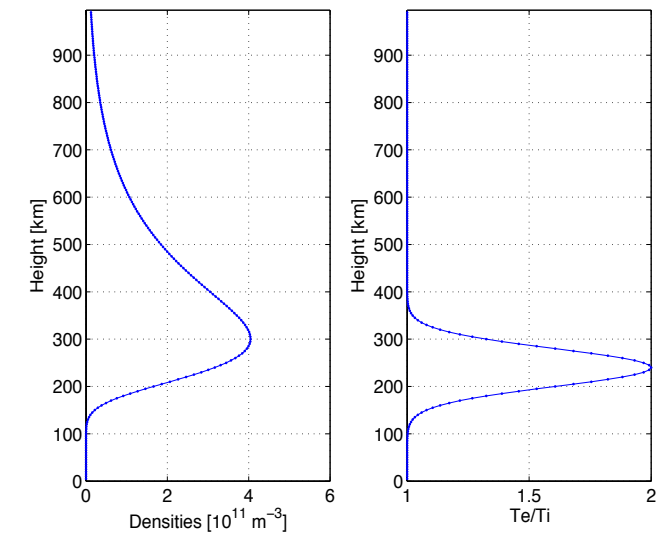



# An example of high-resolution MST-mode data:

SNR map West beam

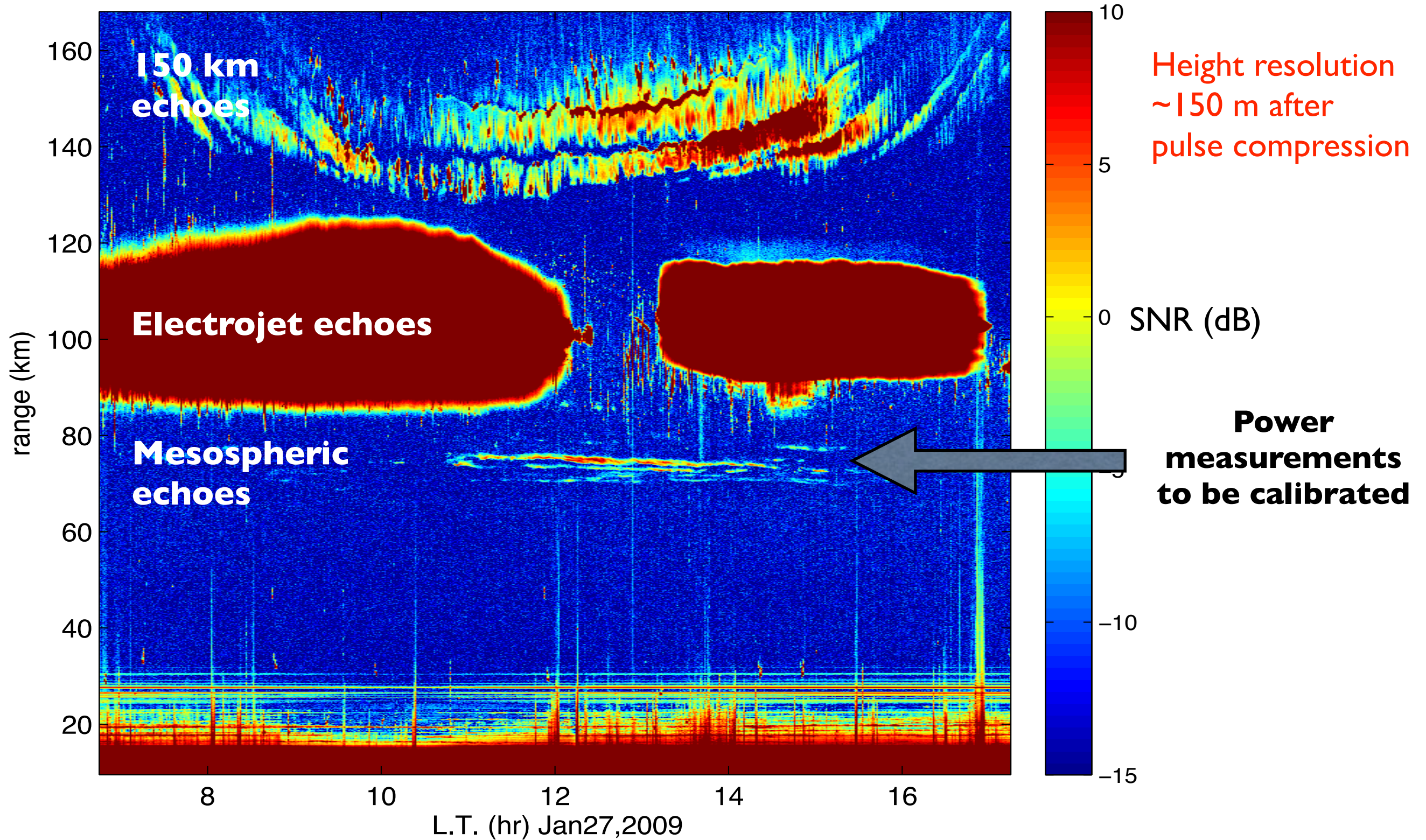



## Jan 2009 --- less South Beam wiggles (solar-min conditions)

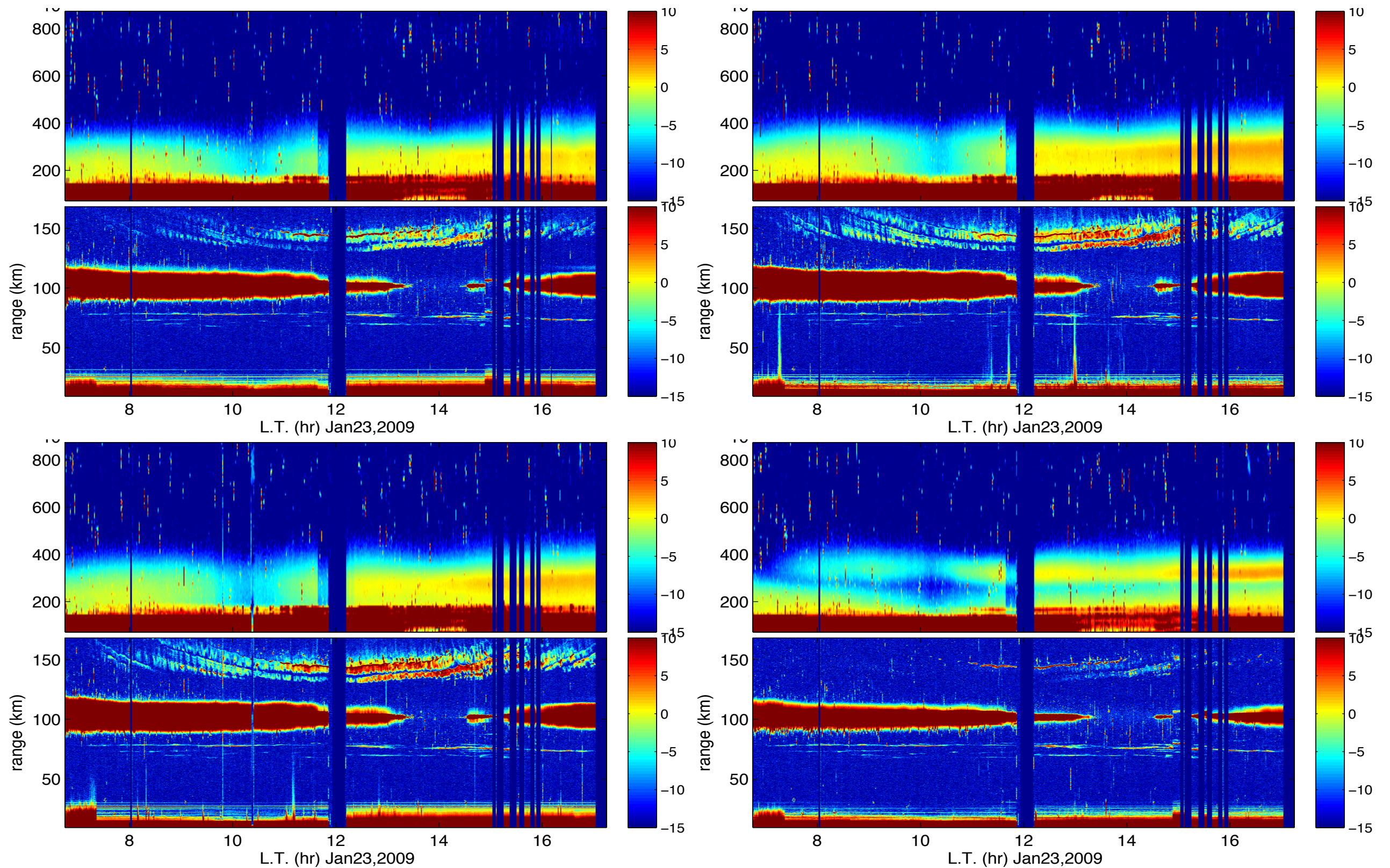



## VIPIR ionograms every two minutes...

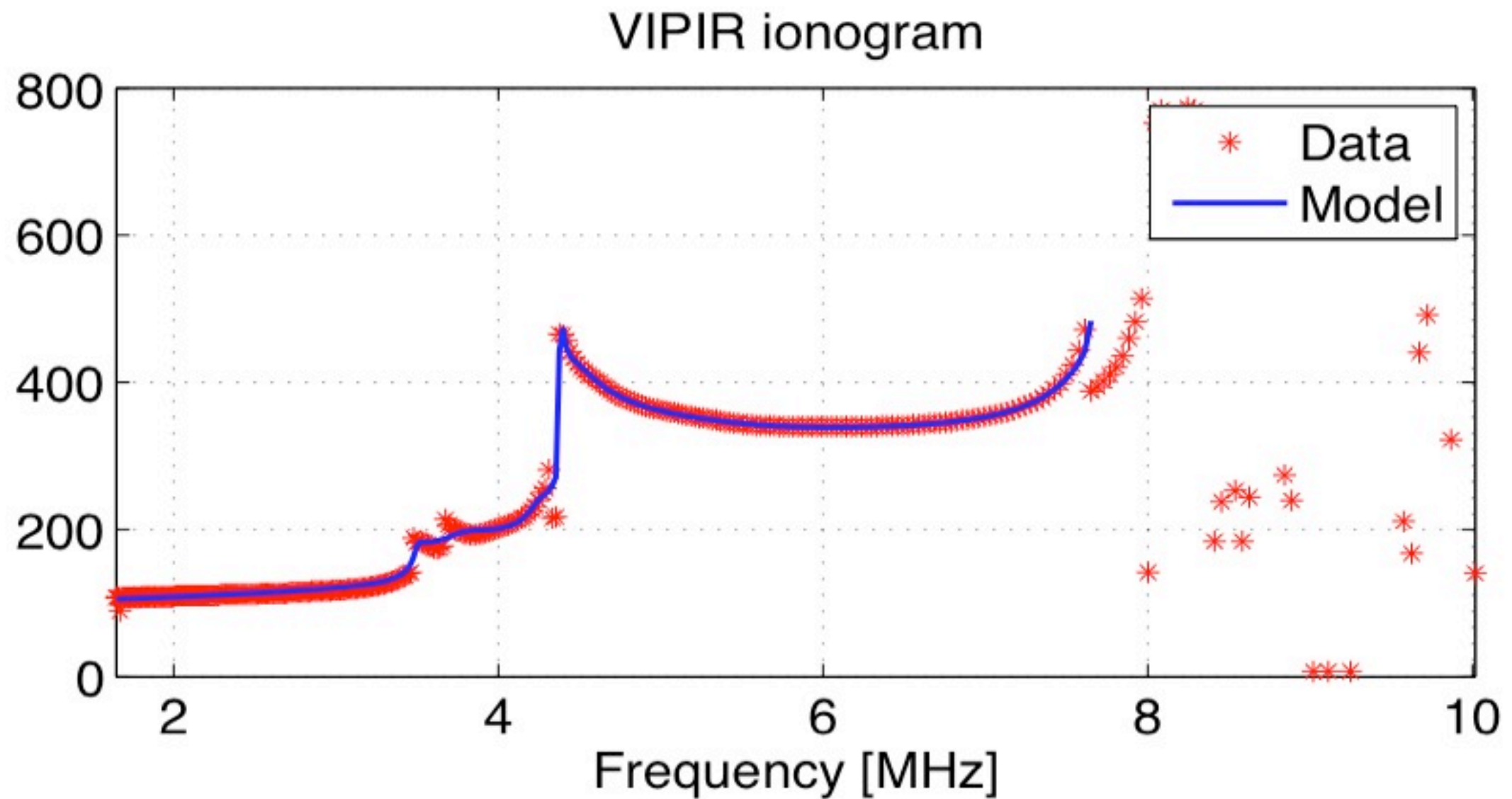

so far, only O-mode data is modeled.



# Fit the observed ISR power profiles to density dependent model equations like

$$\langle |V_r(t)|^2 \rangle = \frac{\kappa}{r^2} \int d\Omega G_{tx} G_{rx} \tilde{\sigma}$$

$$\tilde{\sigma} = 4\pi r_e^2 N_e f\left(\frac{T_e}{T_i}\right)$$

and estimate the “calibration constants”

$$\kappa \propto \frac{E_t \delta r}{L}$$

one for each beam.

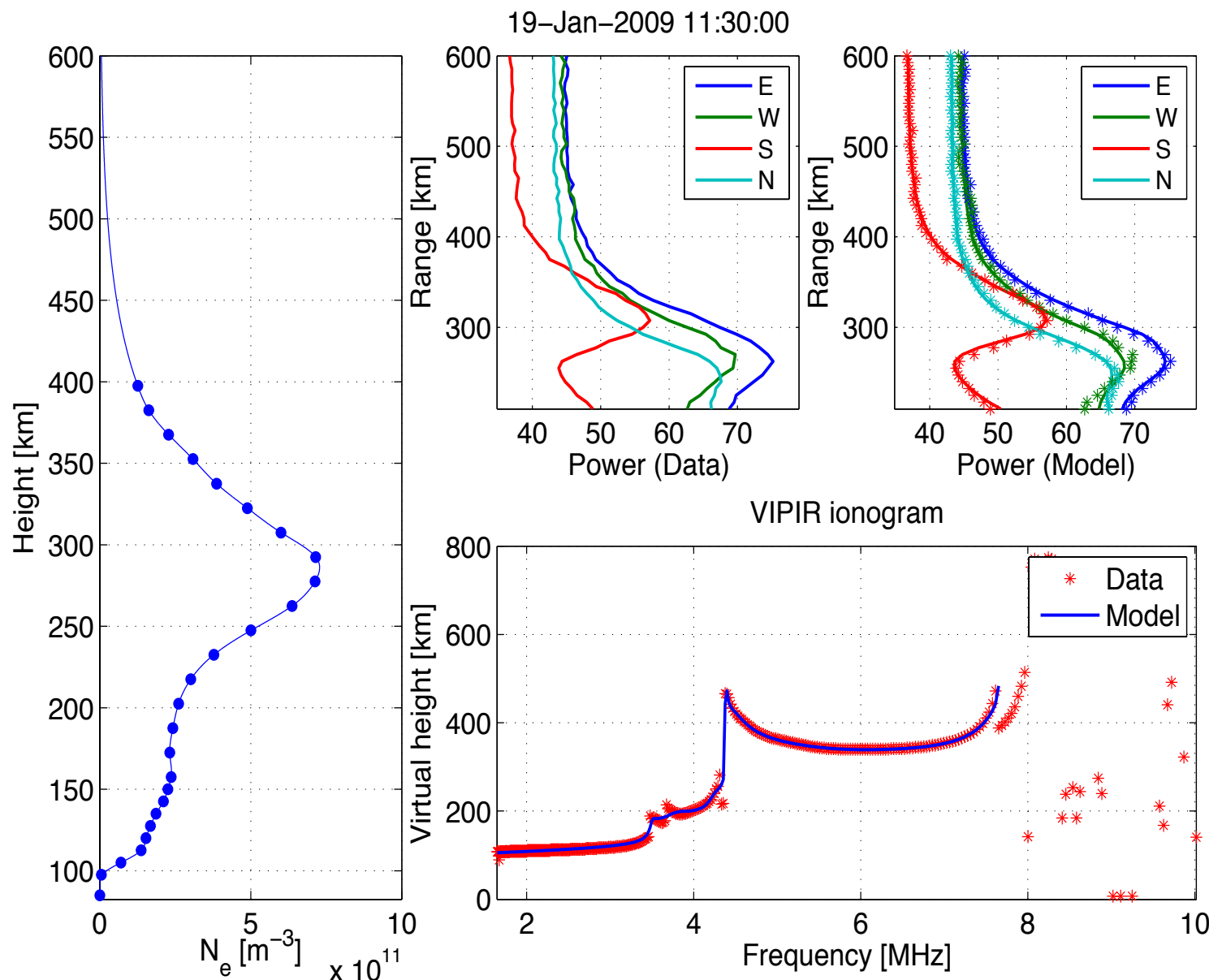

Forward model details...

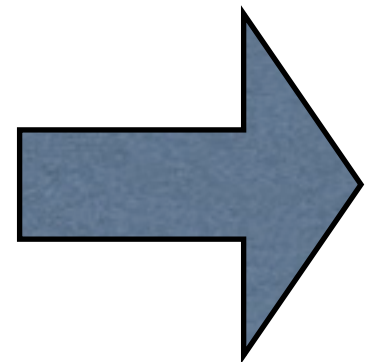

# Dependence of cross-section on $T_e/T_i$ and magnetic aspect angle

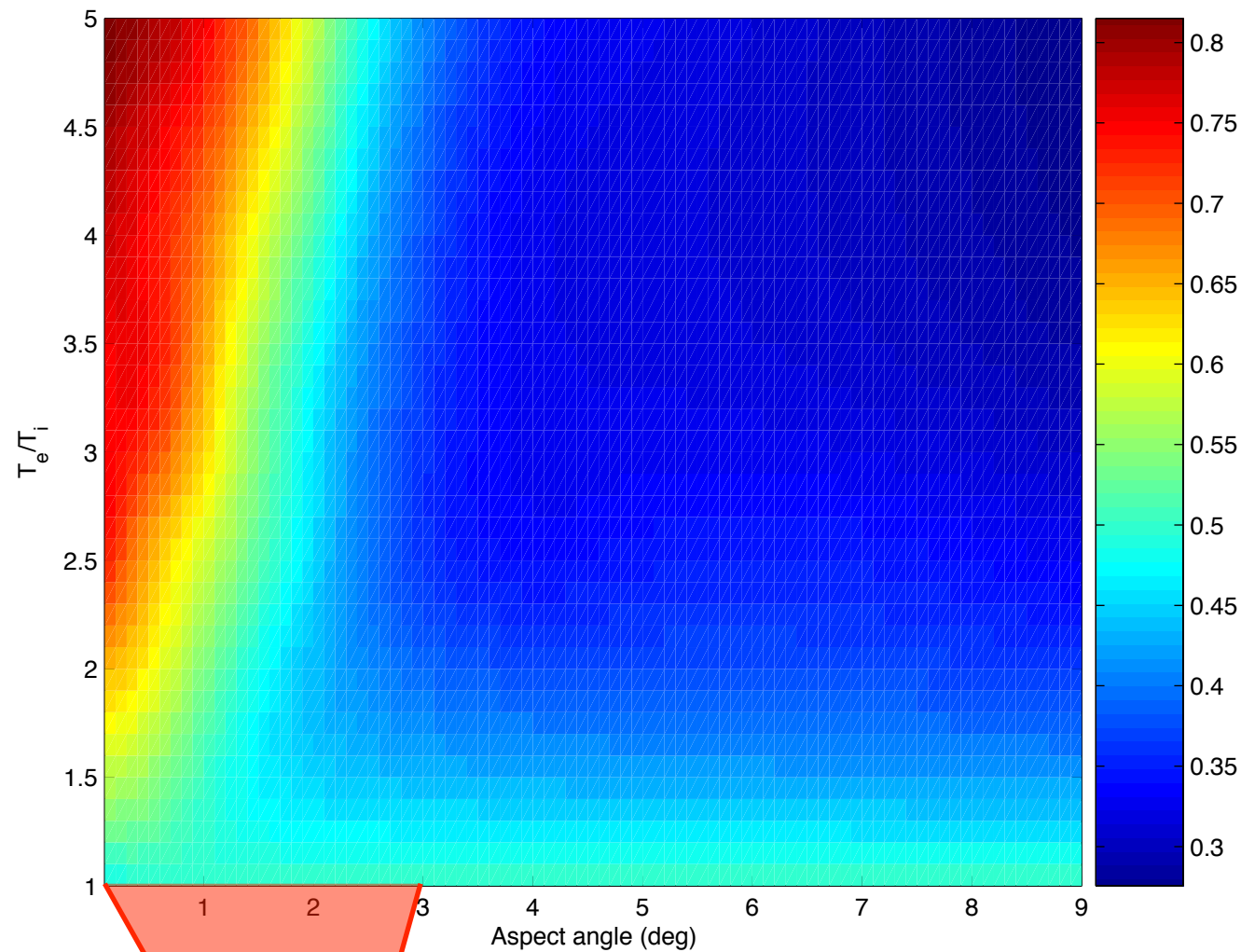

Using the collisional IS spectra we compute IS-RCS as function of magnetic aspect angle and  $T_e/T_i$ .

$$\tilde{\sigma} = 4\pi r_e^2 N_e f\left(\frac{T_e}{T_i}\right)$$



Jicamarca antenna beams illuminate a range of magnetic aspect angles

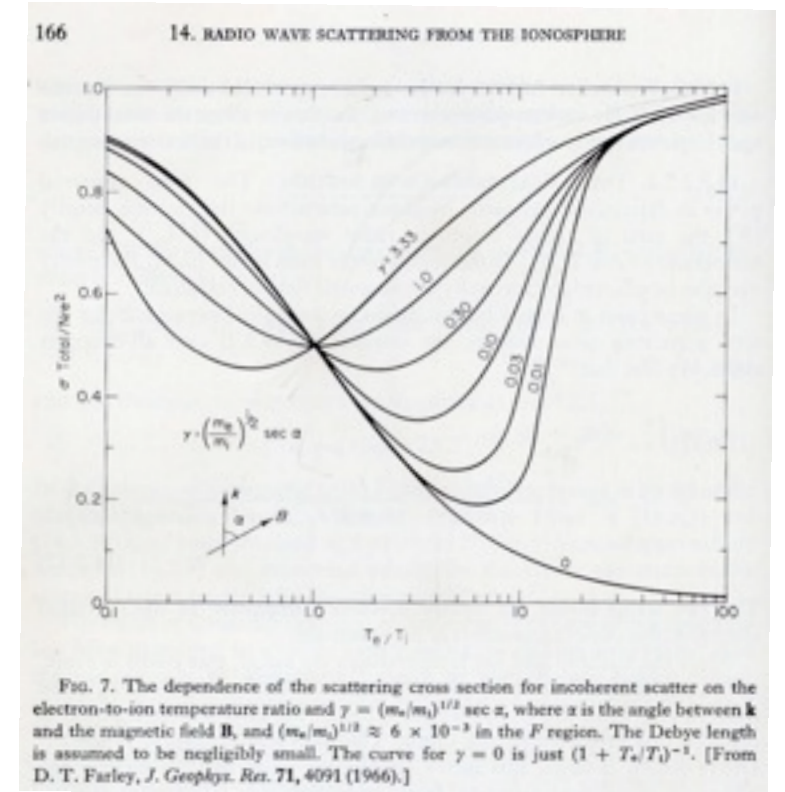



A magneto-ionic propagation problem through a multi-slab ionosphere model:

Polarization unit vector:  $\hat{p}_x = \frac{\hat{k} \times \hat{k} \times \hat{x}}{|\hat{k} \times \hat{k} \times \hat{x}|} \equiv E_{x0}\hat{x} + E_{y0}\hat{y} + E_{z0}\hat{z} \equiv E_{\theta0}\hat{\theta} + E_{\phi0}\hat{\phi}$

$$Y_L = Y \cos \theta, \quad Y_T = Y \sin \theta, \quad Y = \frac{\Omega}{\omega}, \quad X = \frac{\omega_p^2}{\omega^2}$$

$$F_O = F_1 - F_2, \quad F_X = F_1 + F_2, \quad F_1 = \frac{Y_T^2/2}{1 - X}, \quad F_2^2 = F_1^2 + Y_L^2$$

$$n_{O,X}^2 = 1 - \frac{X}{1 - F_{O,X}}$$

$$\Delta n = \frac{n_O - n_X}{2} \quad \bar{n} = \frac{n_O + n_X}{2} \quad a = \frac{F_O}{Y_L}$$

$$\mathbf{E}(\delta r) = \begin{bmatrix} E_\theta \\ E_\phi \end{bmatrix} = \frac{e^{-jk\bar{n}\delta r}}{1 + a^2} \underbrace{\begin{bmatrix} a^2 e^{jk\Delta n\delta r} + e^{-jk\Delta n\delta r} & 2a \sin(k\Delta n\delta r) \\ -2a \sin(k\Delta n\delta r) & a^2 e^{-jk\Delta n\delta r} + e^{jk\Delta n\delta r} \end{bmatrix}}_{\vec{M}} \begin{bmatrix} E_{\theta_0} \\ E_{\phi_0} \end{bmatrix}$$

Iterate after modifying  $\Delta n, \bar{n}, a, \hat{\theta}, \hat{\phi}$  due to slow varying density and  $\vec{B}$

$$v_x \propto \hat{p}_x \cdot (E_\theta \hat{\theta} + E_\phi \hat{\phi}) \quad v_y \propto \hat{p}_y \cdot (E_\theta \hat{\theta} + E_\phi \hat{\phi})$$

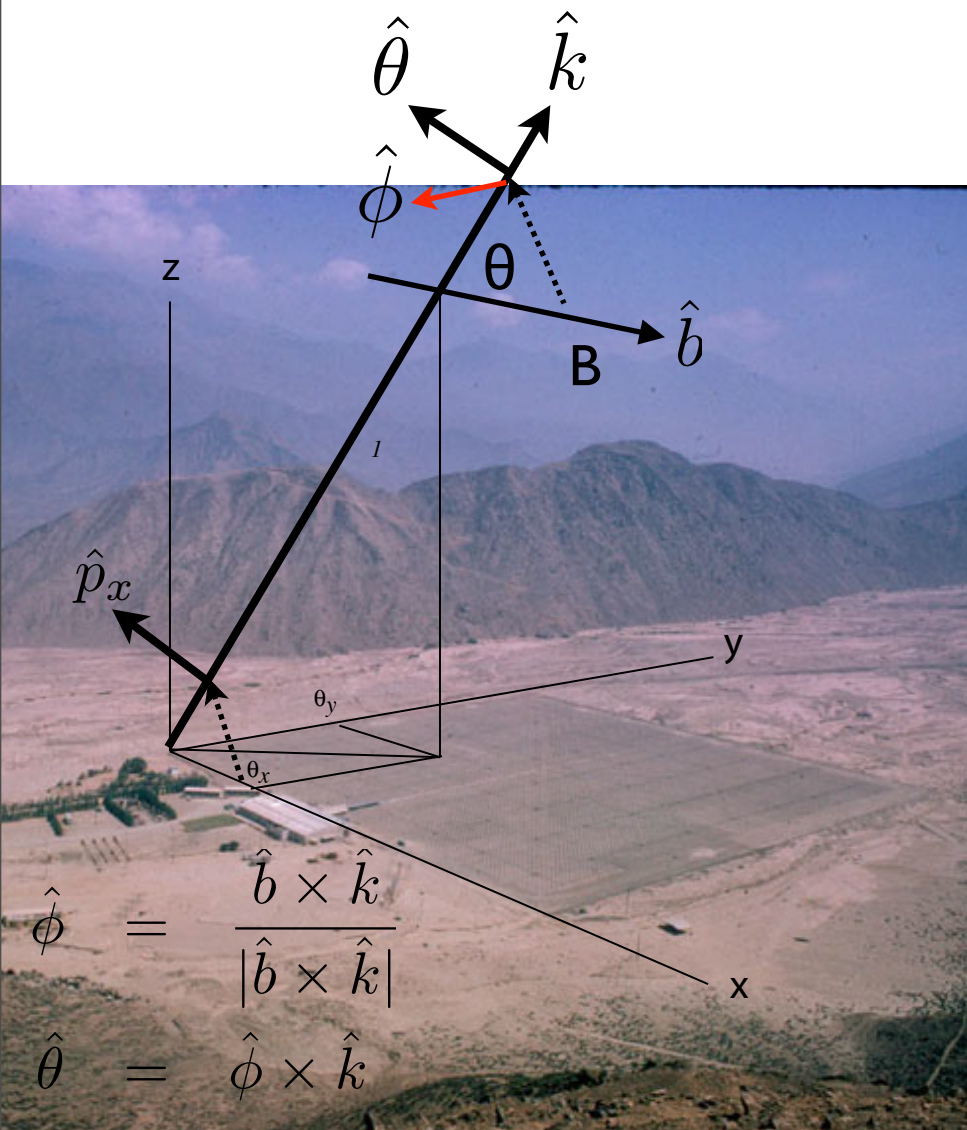



## 2-D integration of power samples in direction cosine coordinates

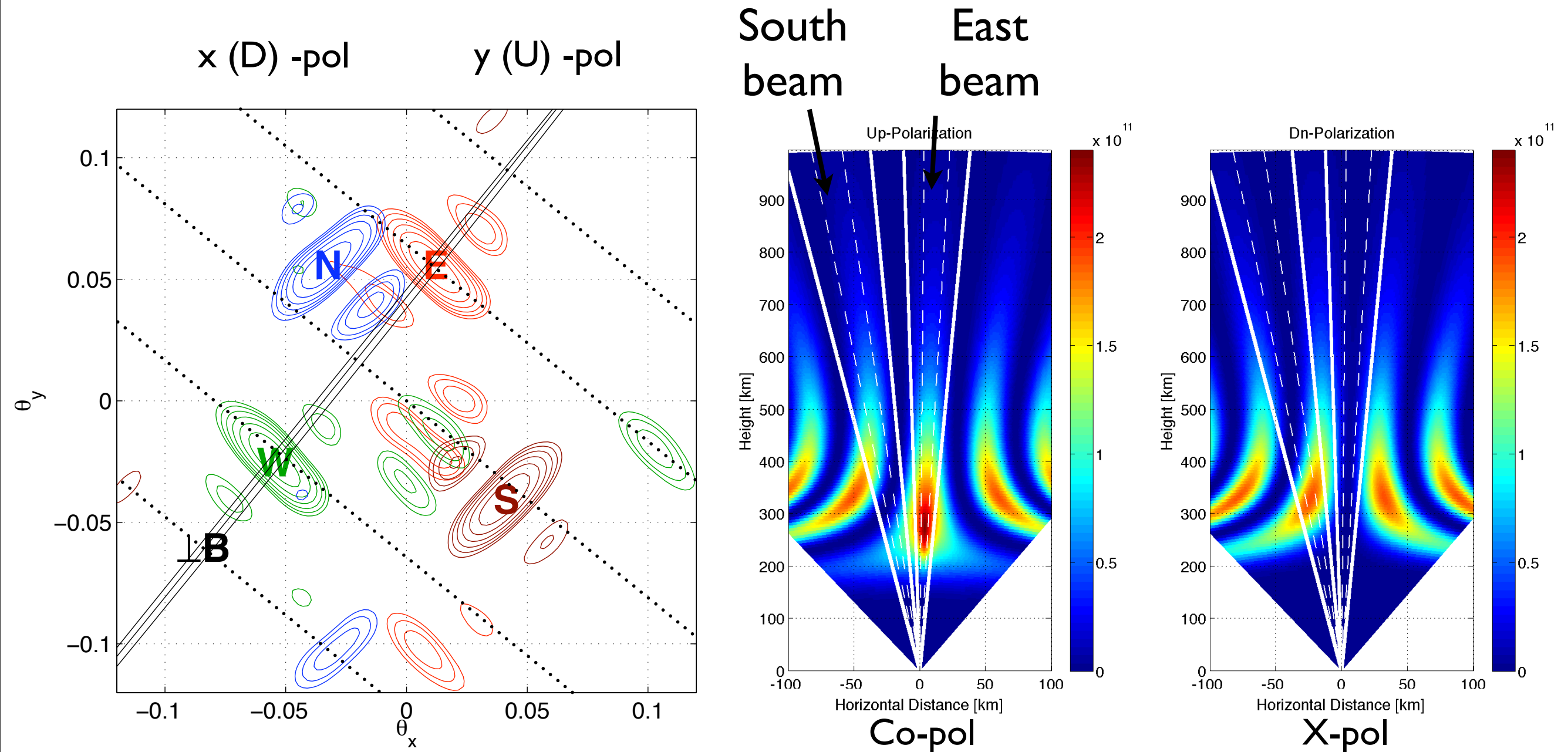

2-D integration implemented using a finite element method (rectangular elements).

## 2-D integration of power samples in direction cosine coordinates

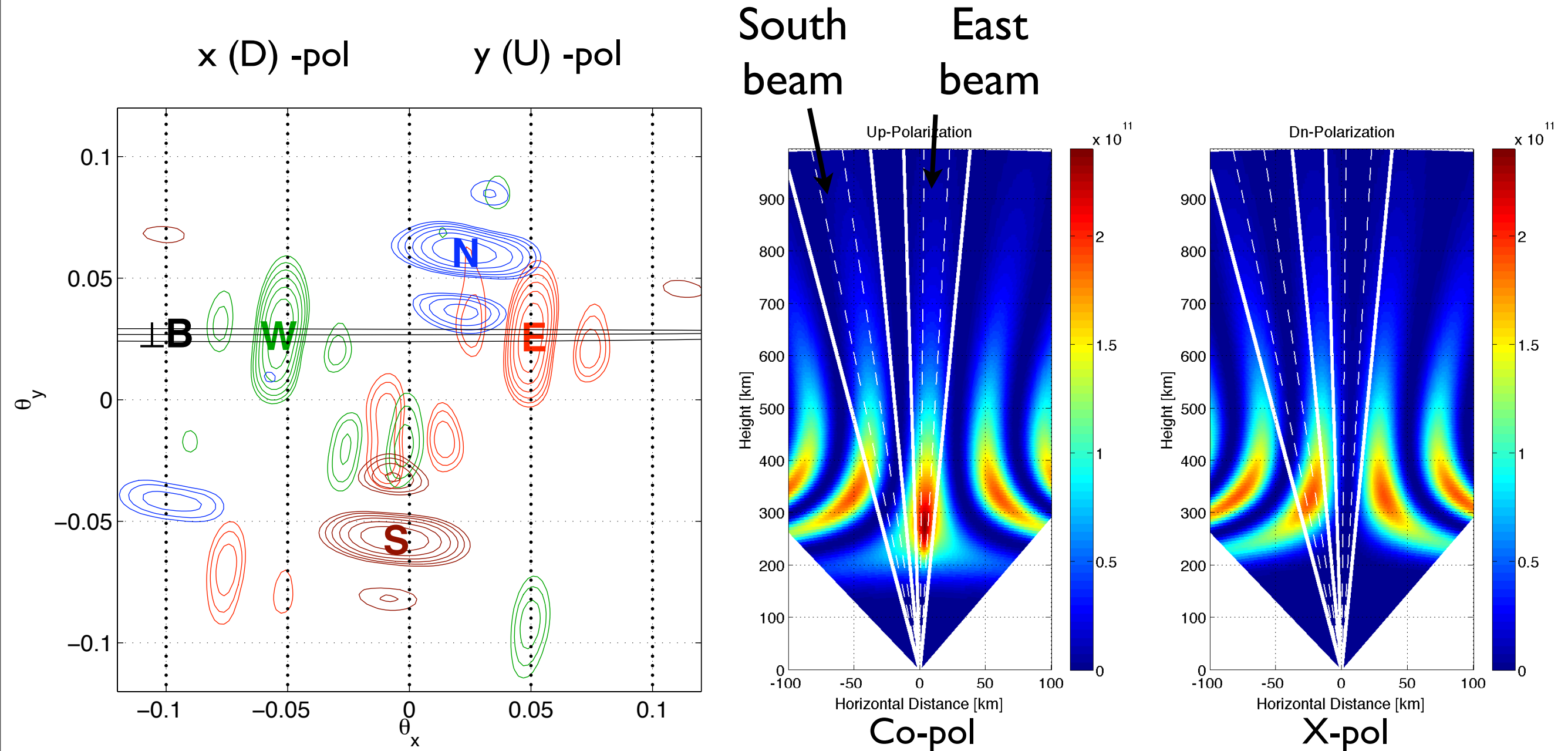

2-D integration implemented using a finite element method (rectangular elements).

$$\langle |V_r(t)|^2 \rangle = \frac{\kappa}{r^2} \int d\Omega G_{tx} G_{rx} \tilde{\sigma}$$

Fit the ISR power profile data from all four beams to power profile model and estimate density and Te/Ti profiles and calibration constants

ISR power data

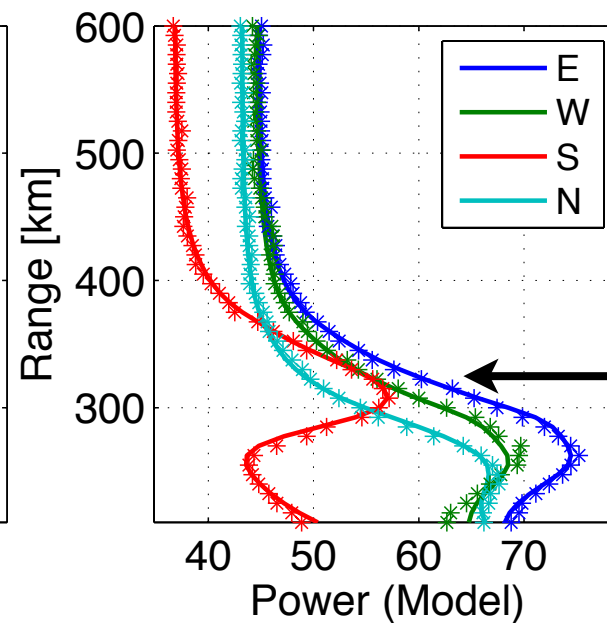
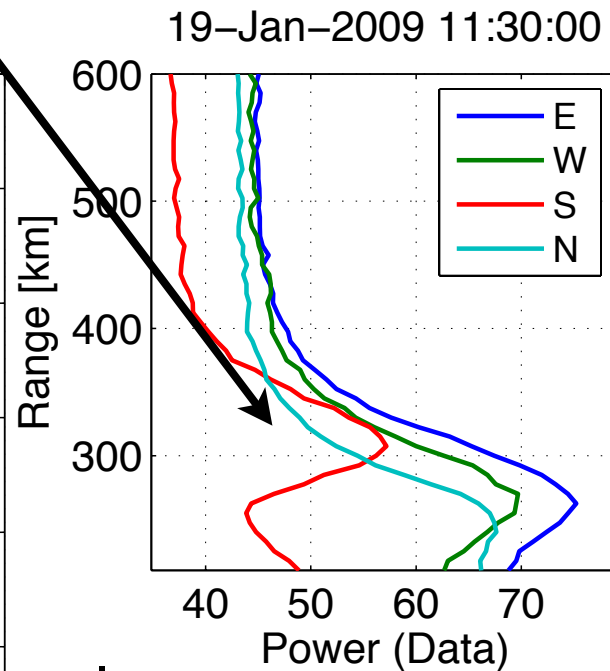
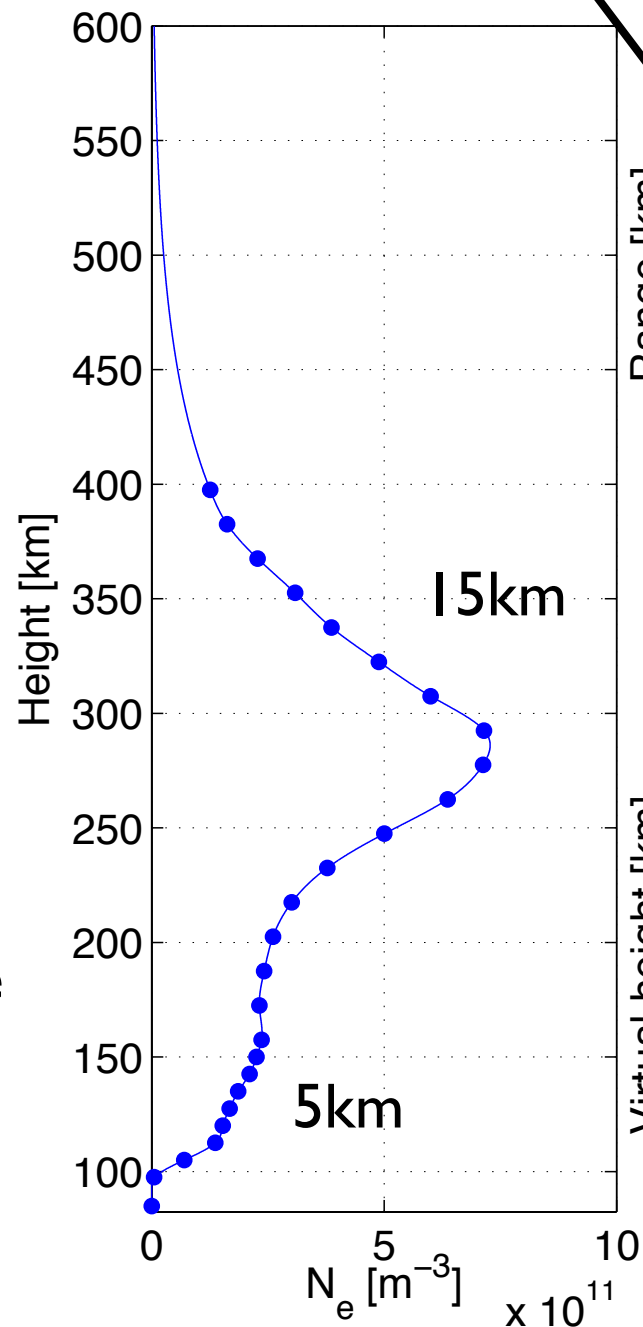

$$\kappa \propto \frac{E_t \delta r}{L}$$

Model fits

Ionogram

VIPIR ionogram

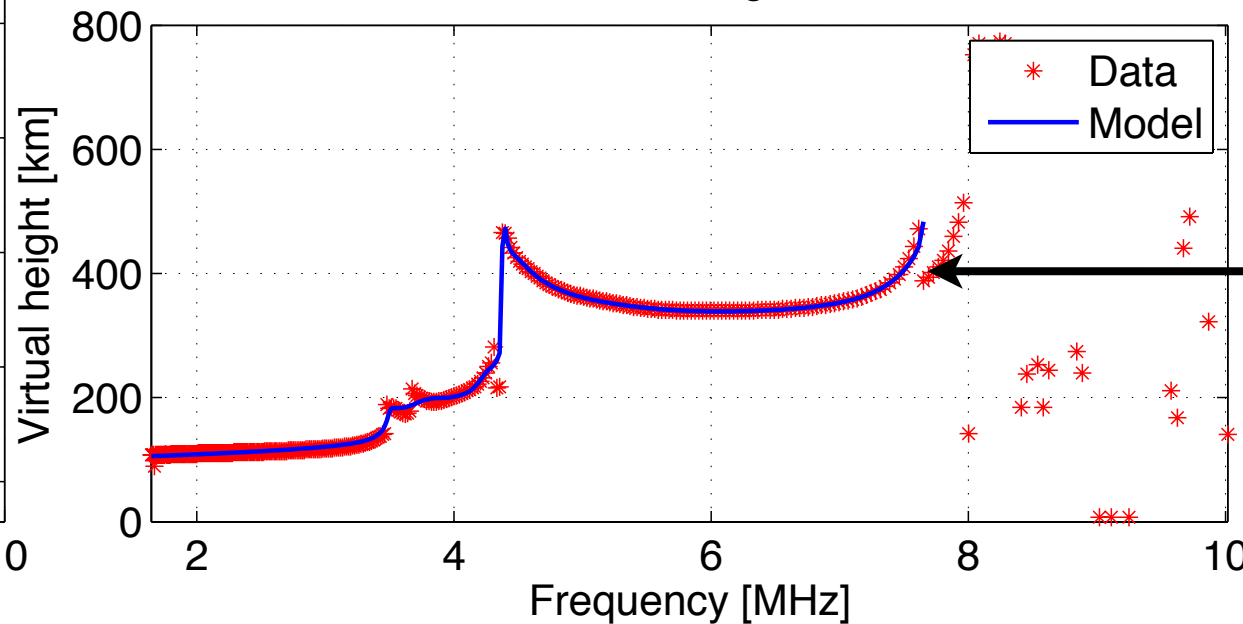

Ionogram data is fitted to obtain E and F1 region density estimates. It improves accuracy of calibration parameters.





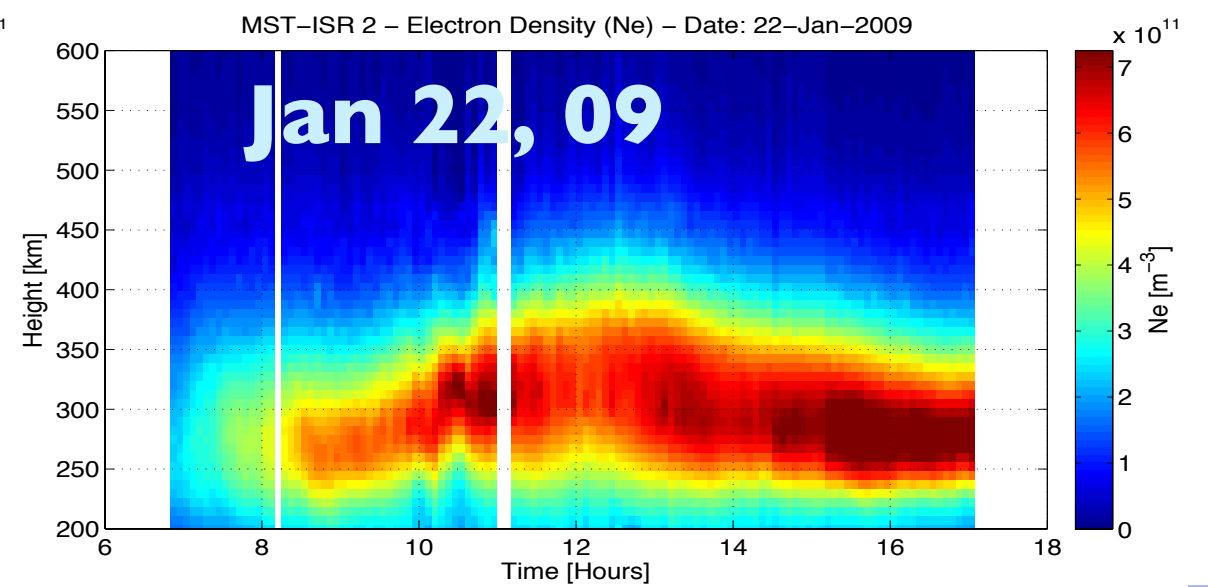
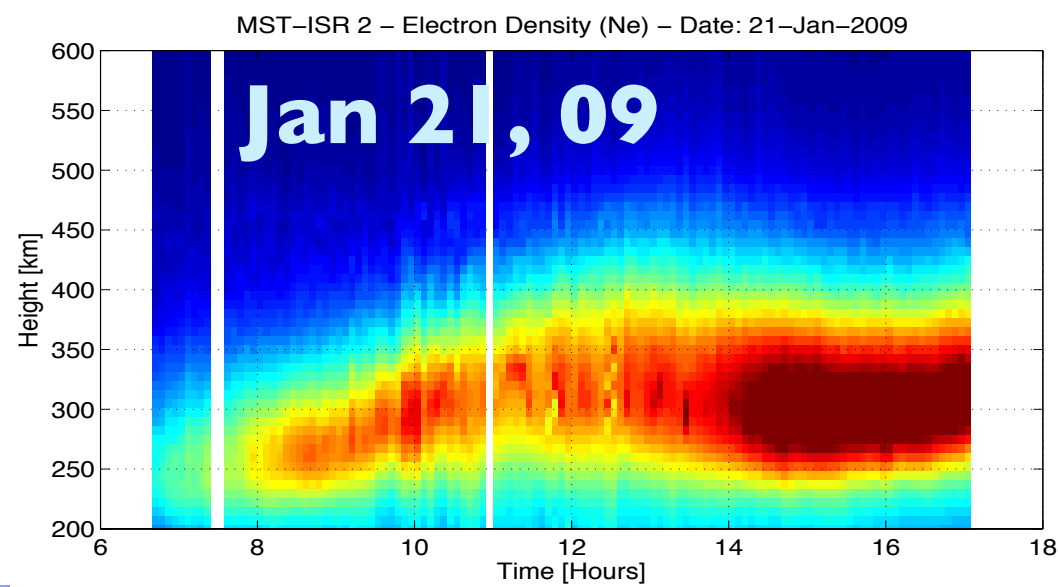
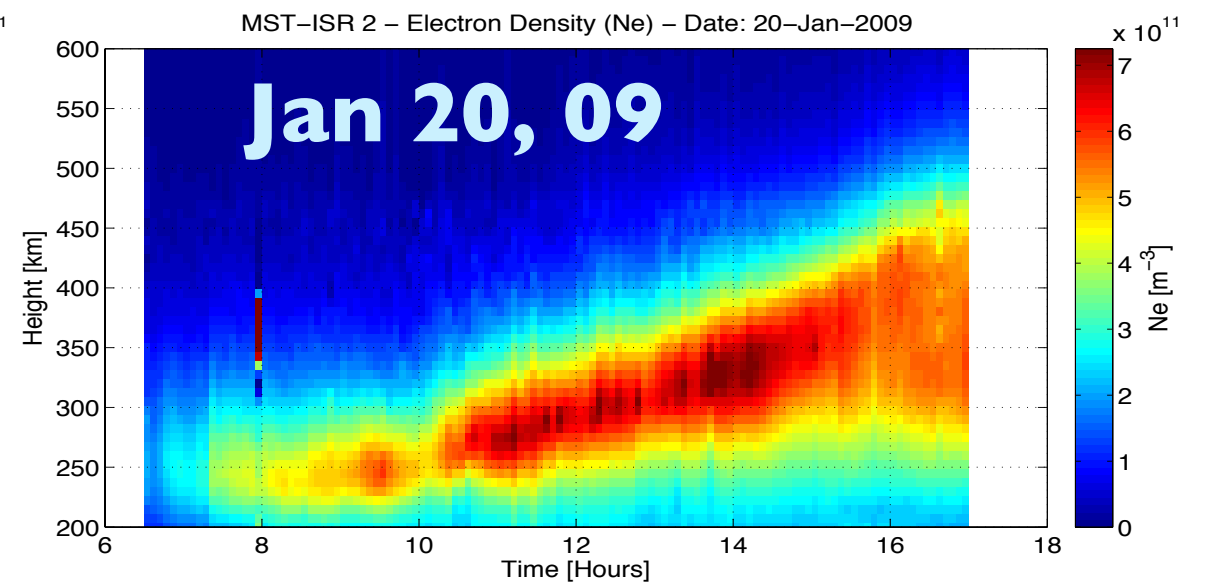
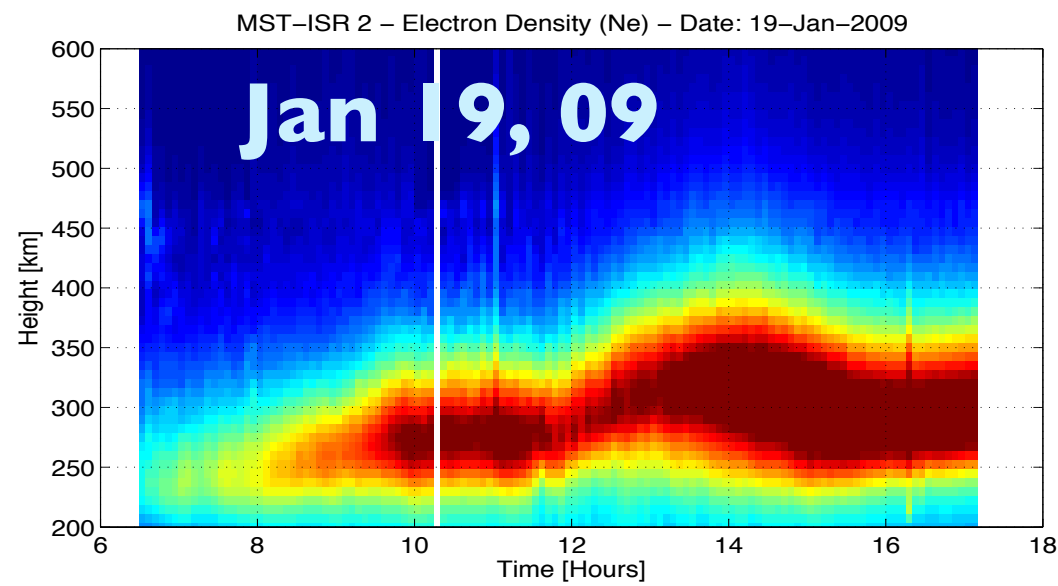
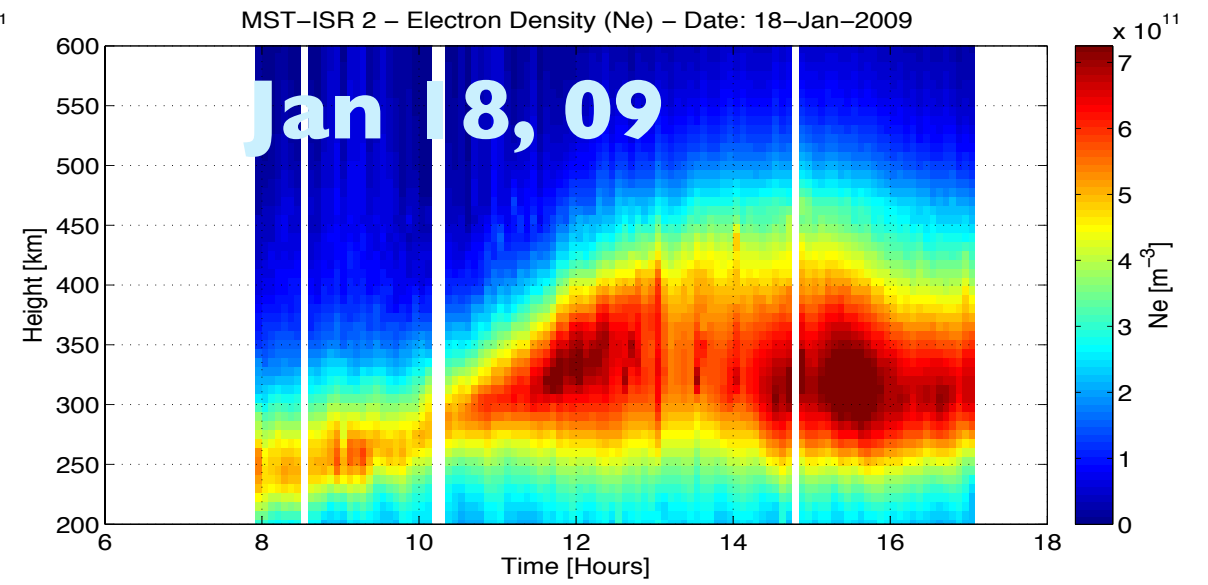
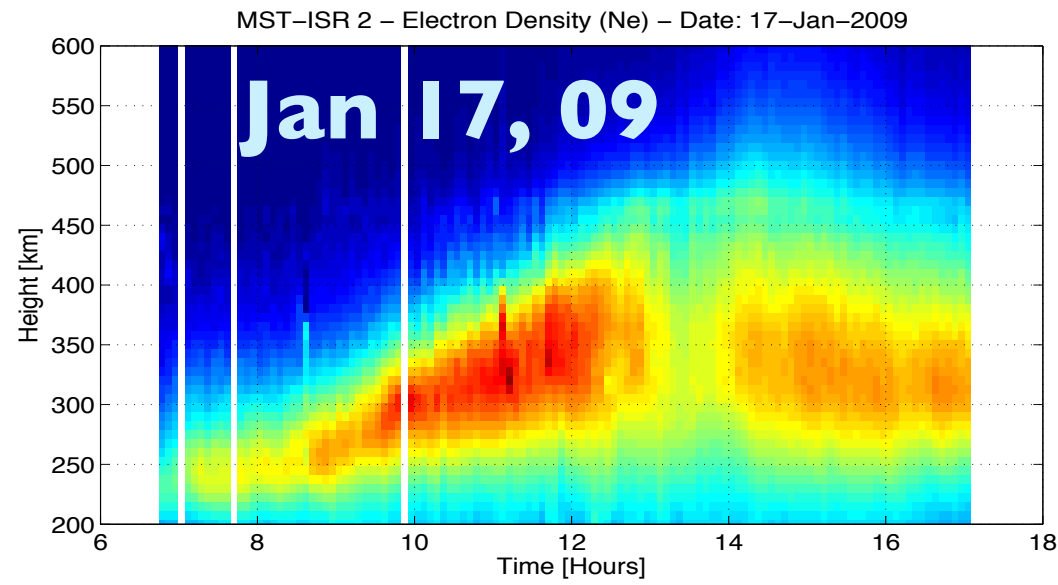

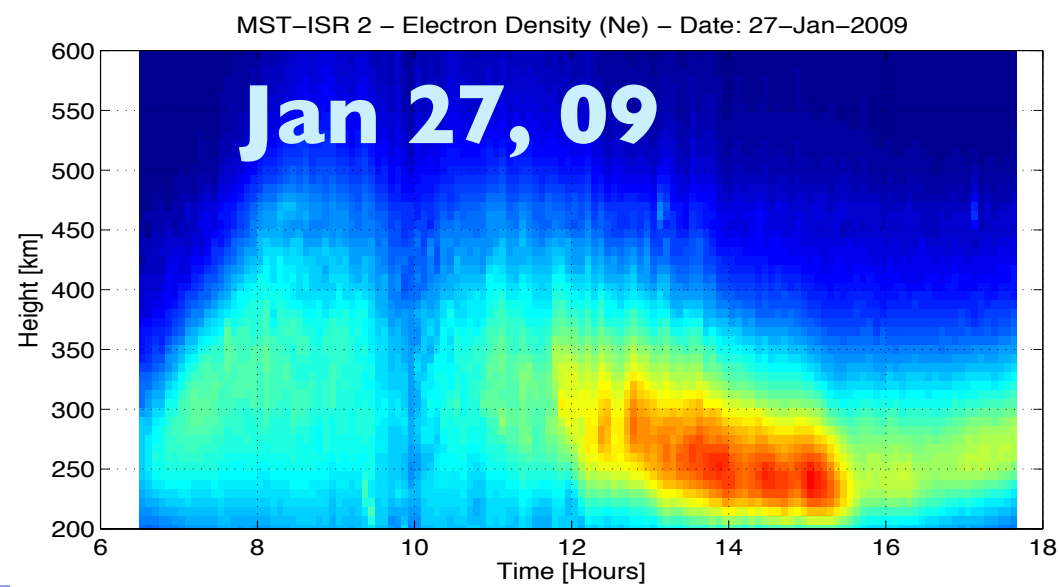
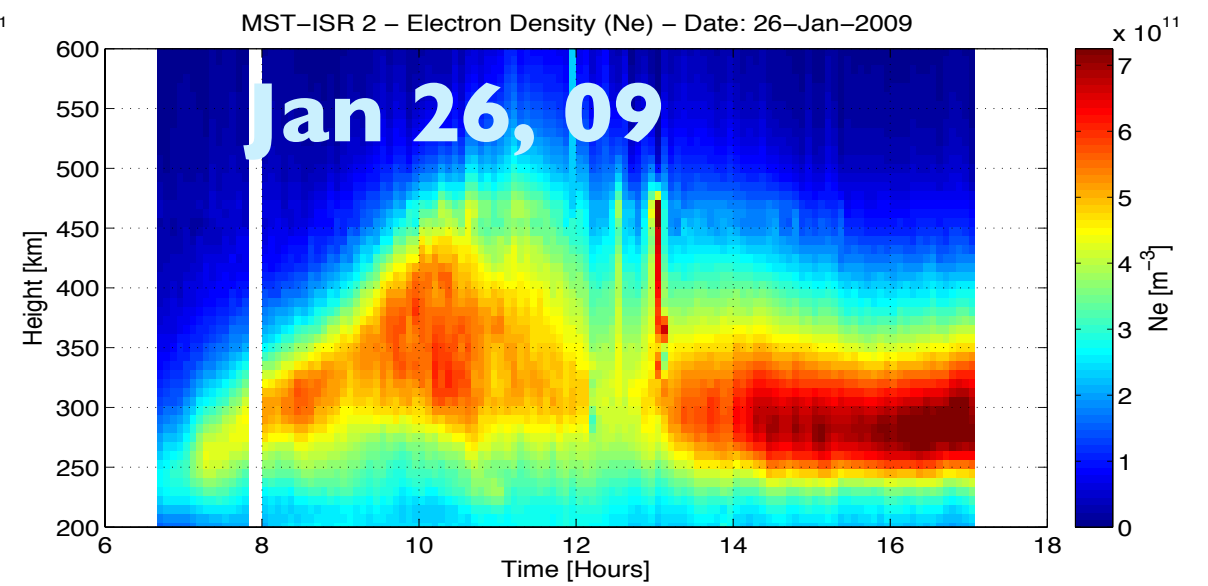
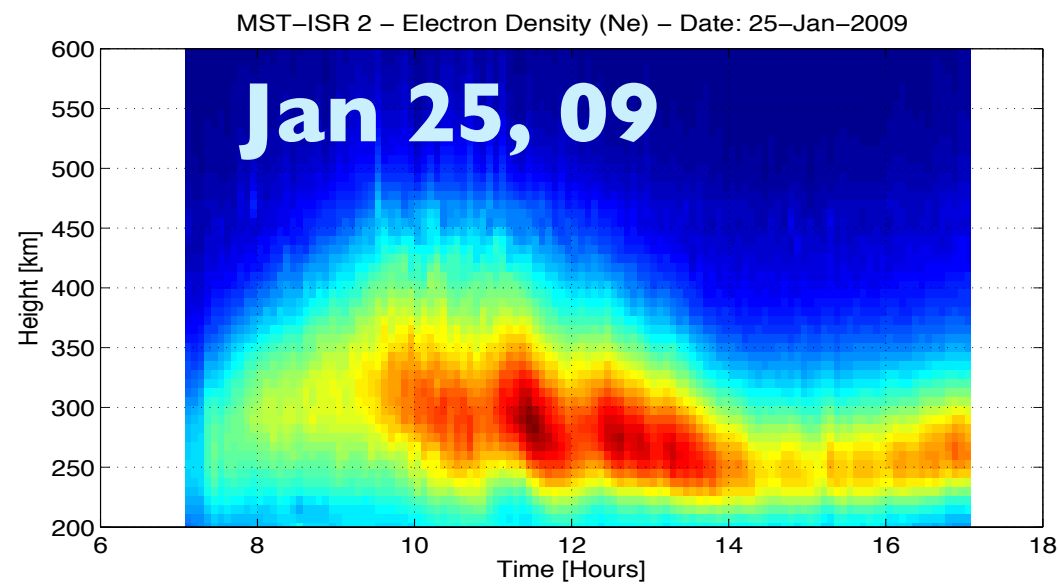
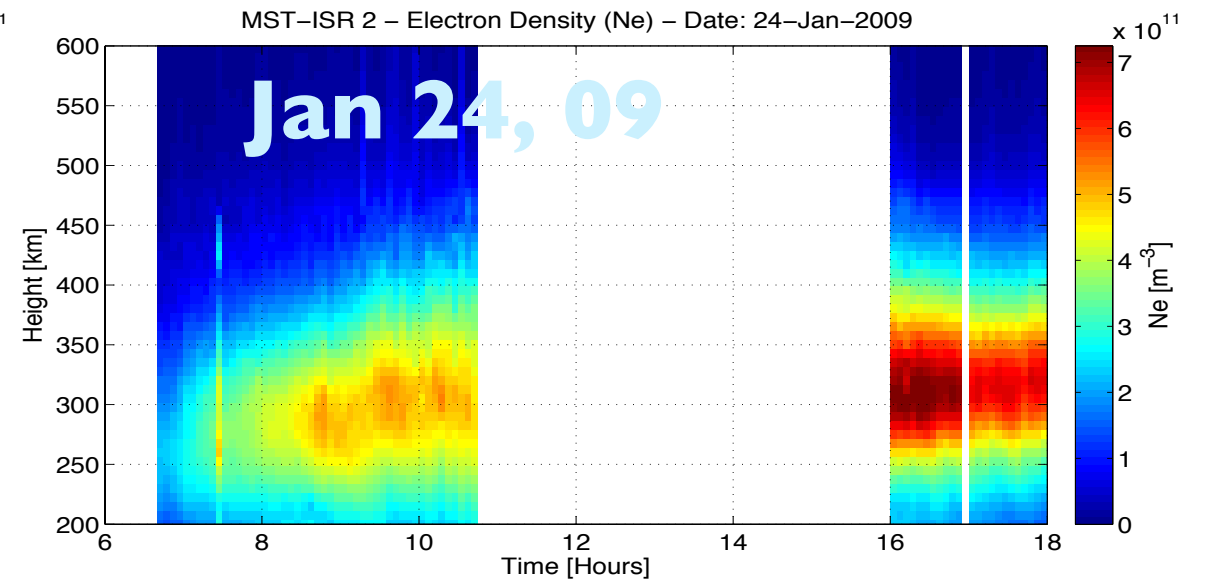
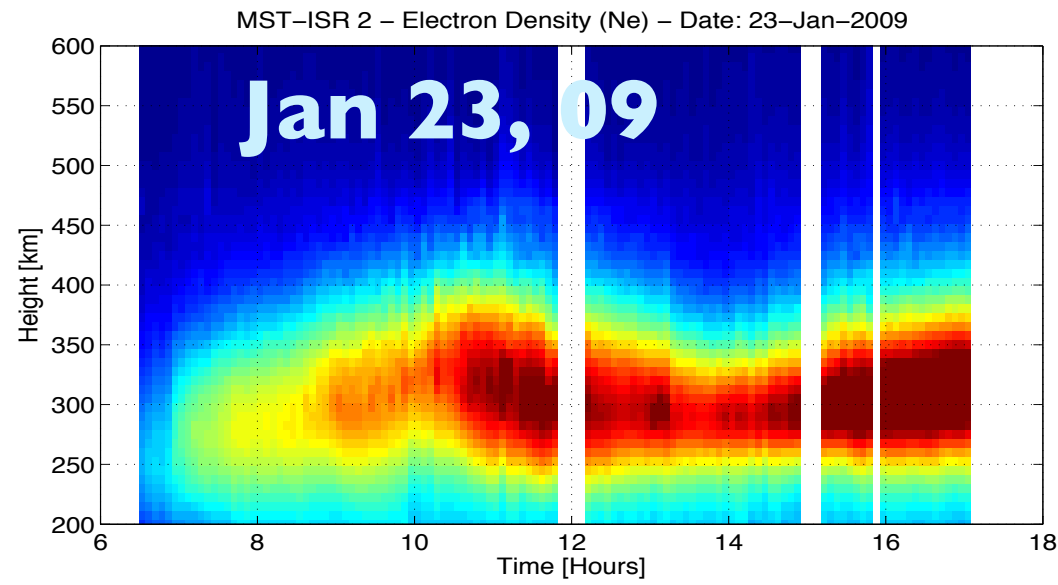

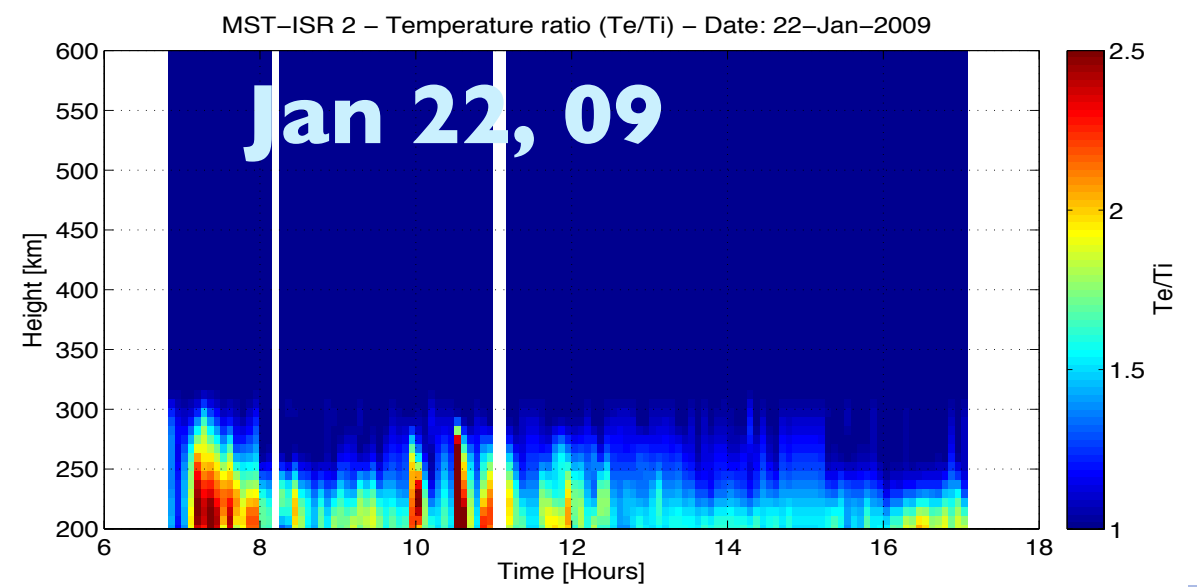
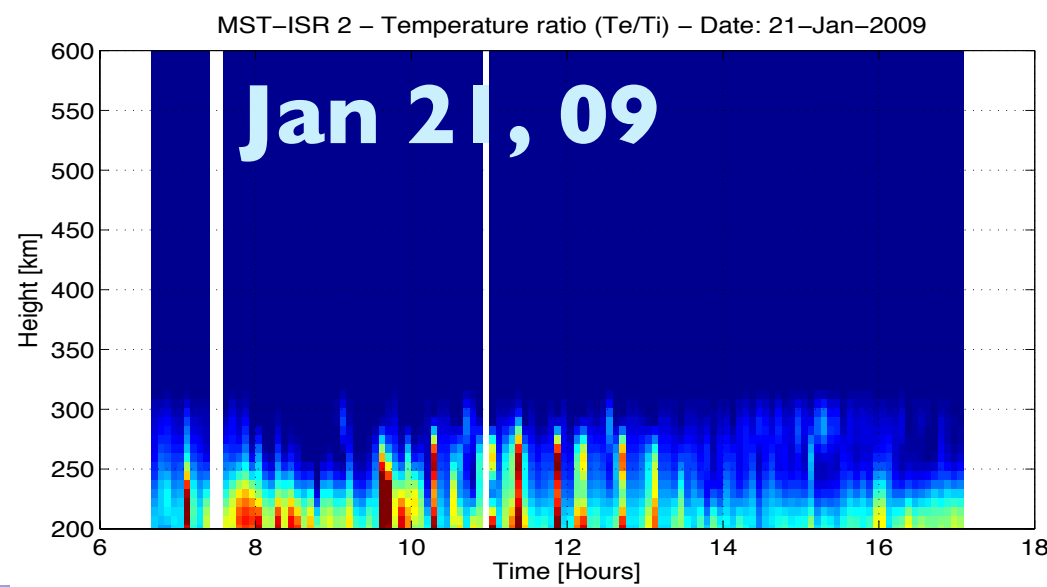
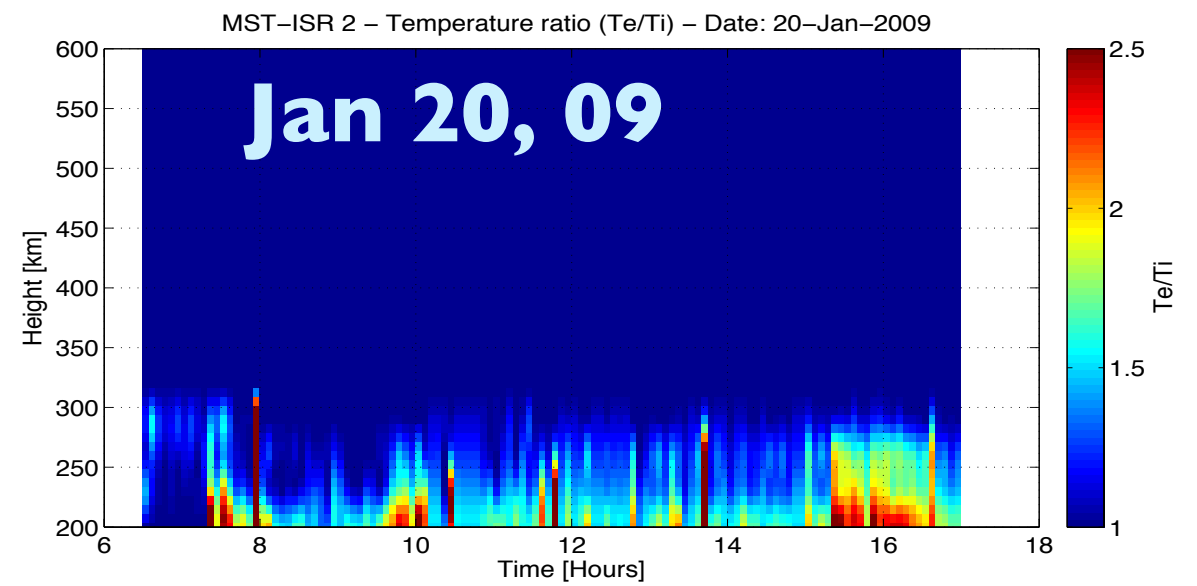
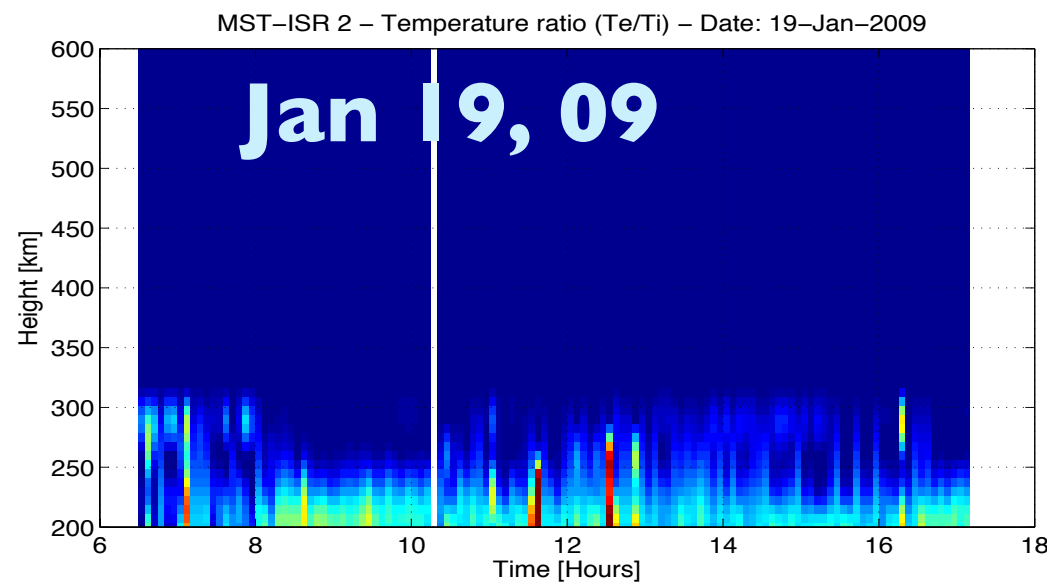
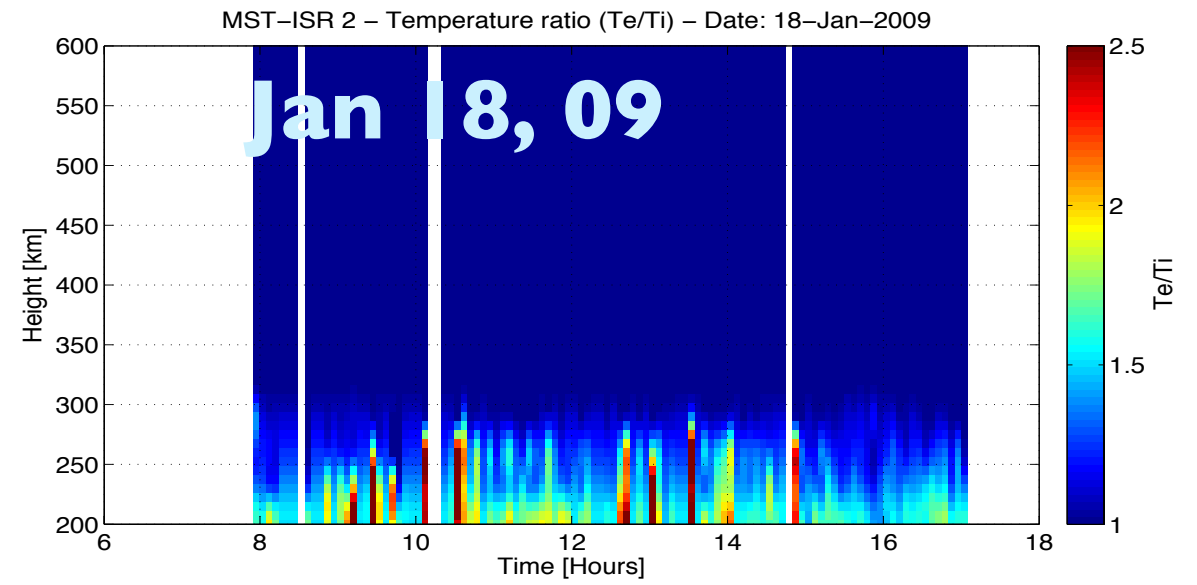
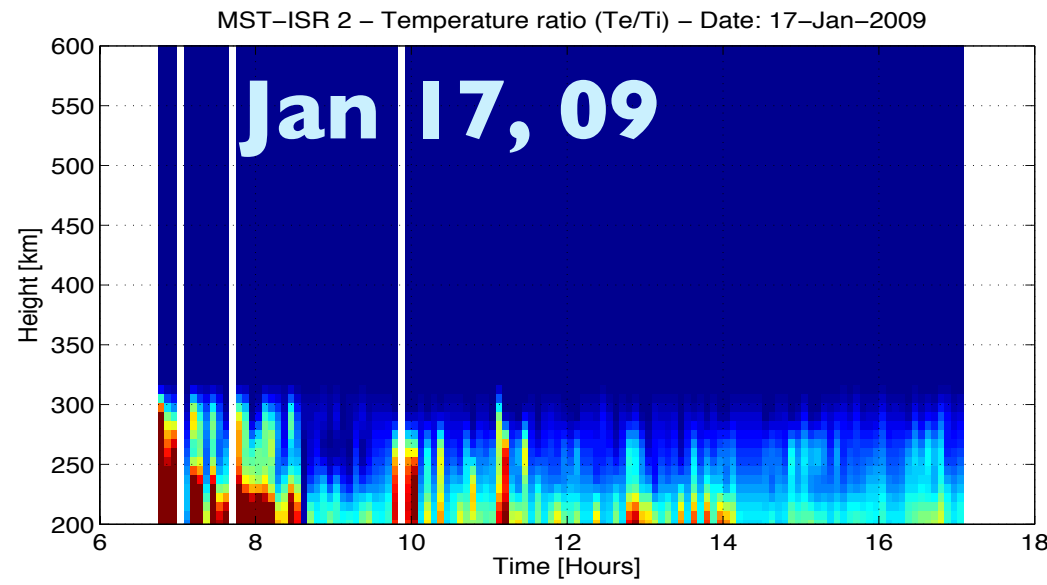



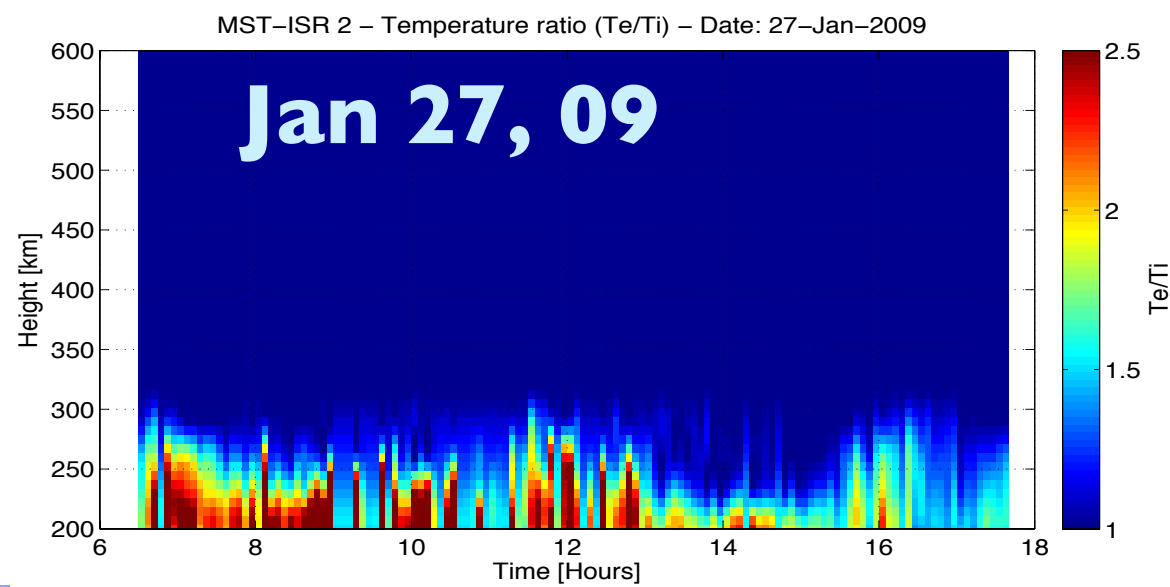
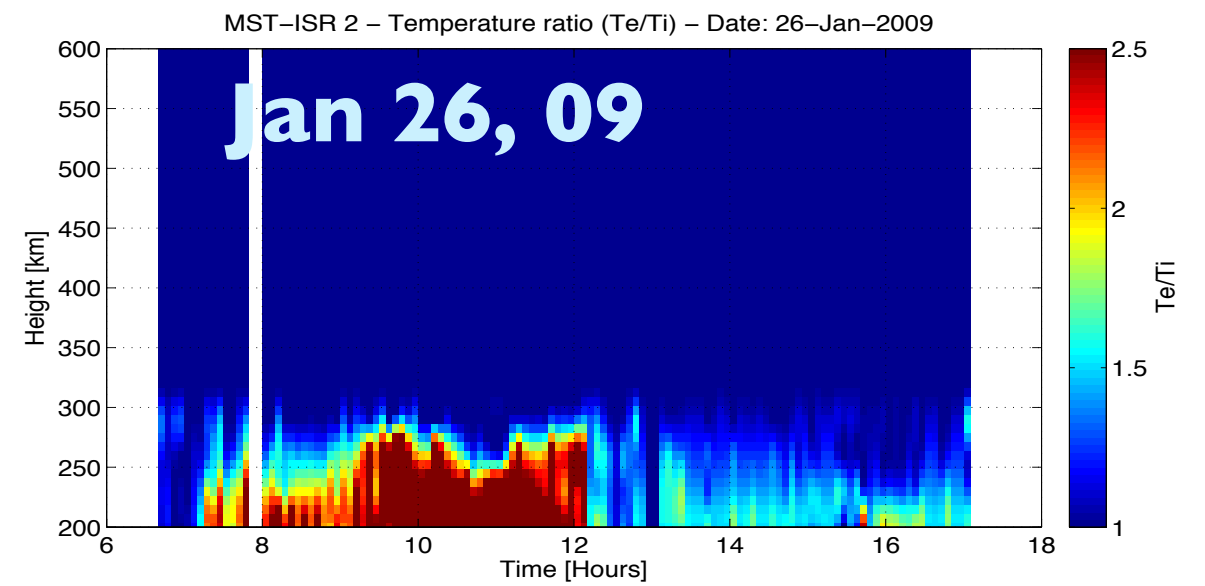
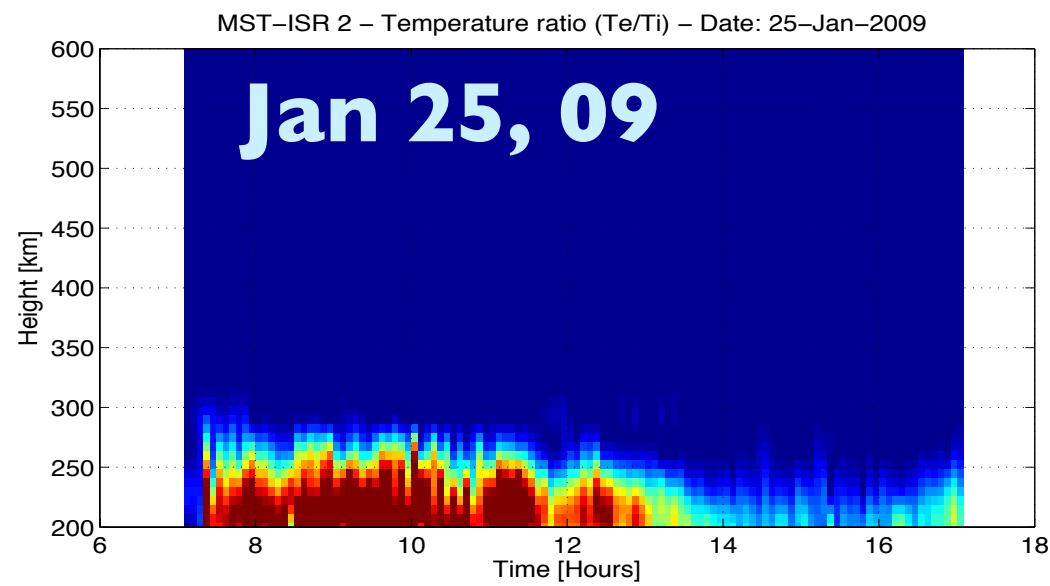
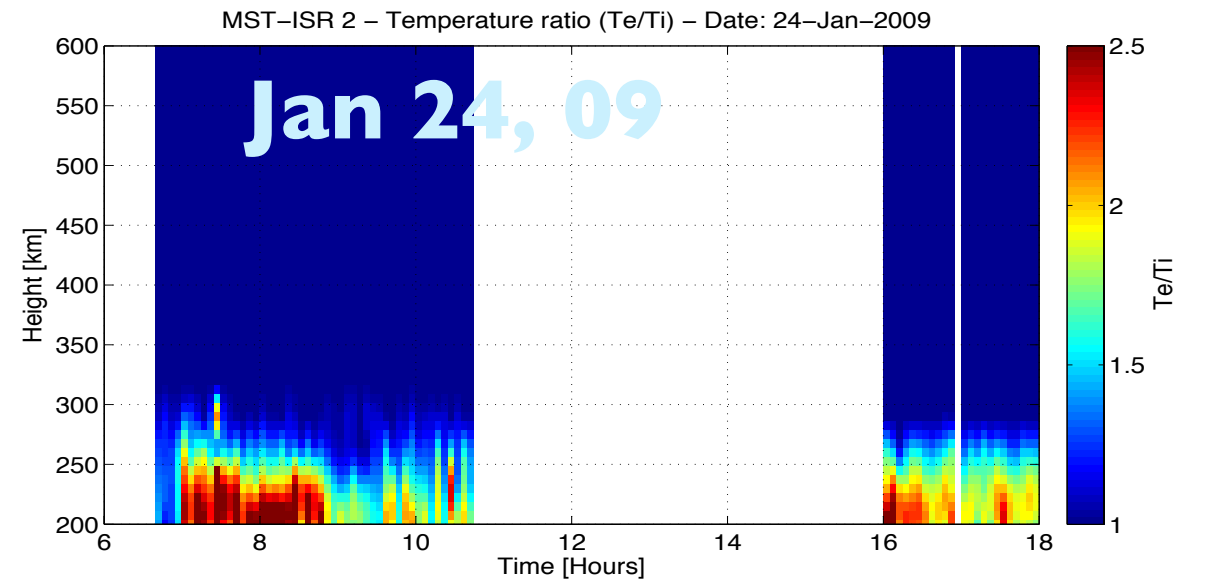
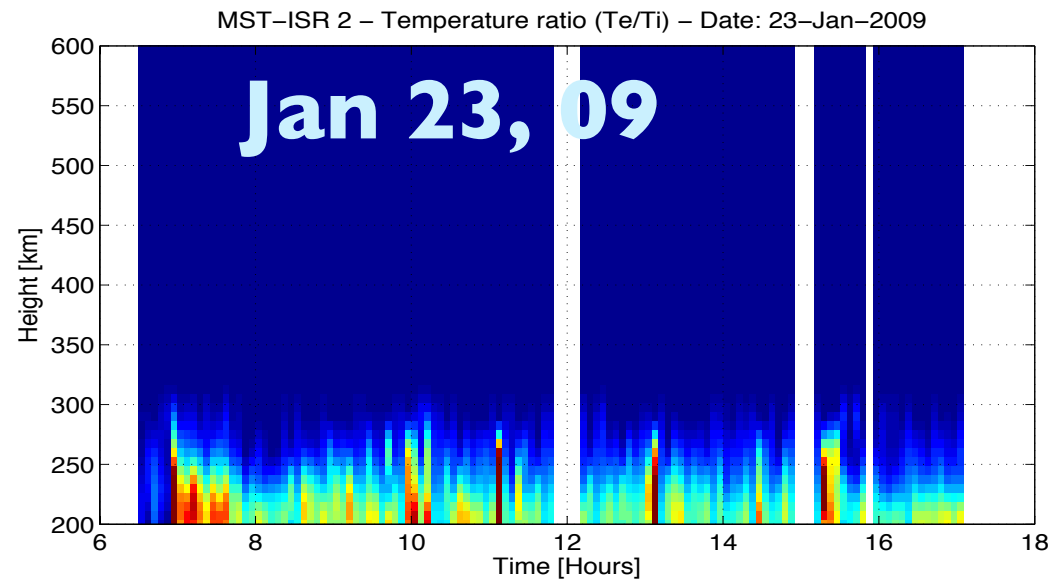

# Calibration Parameters

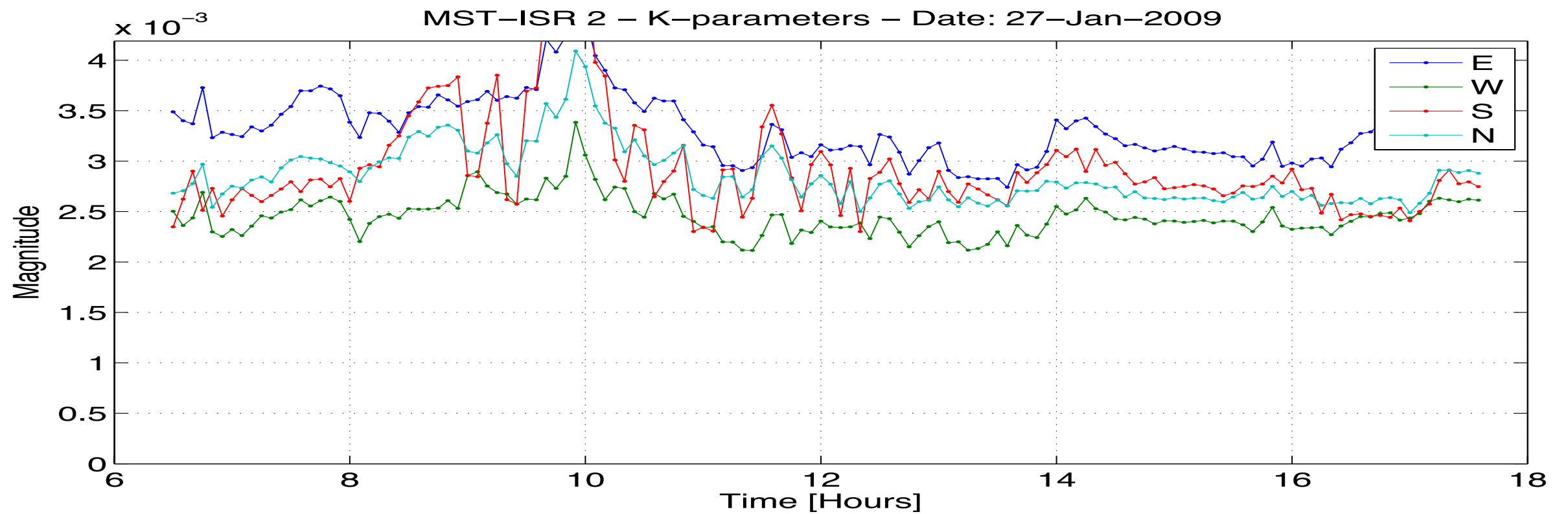
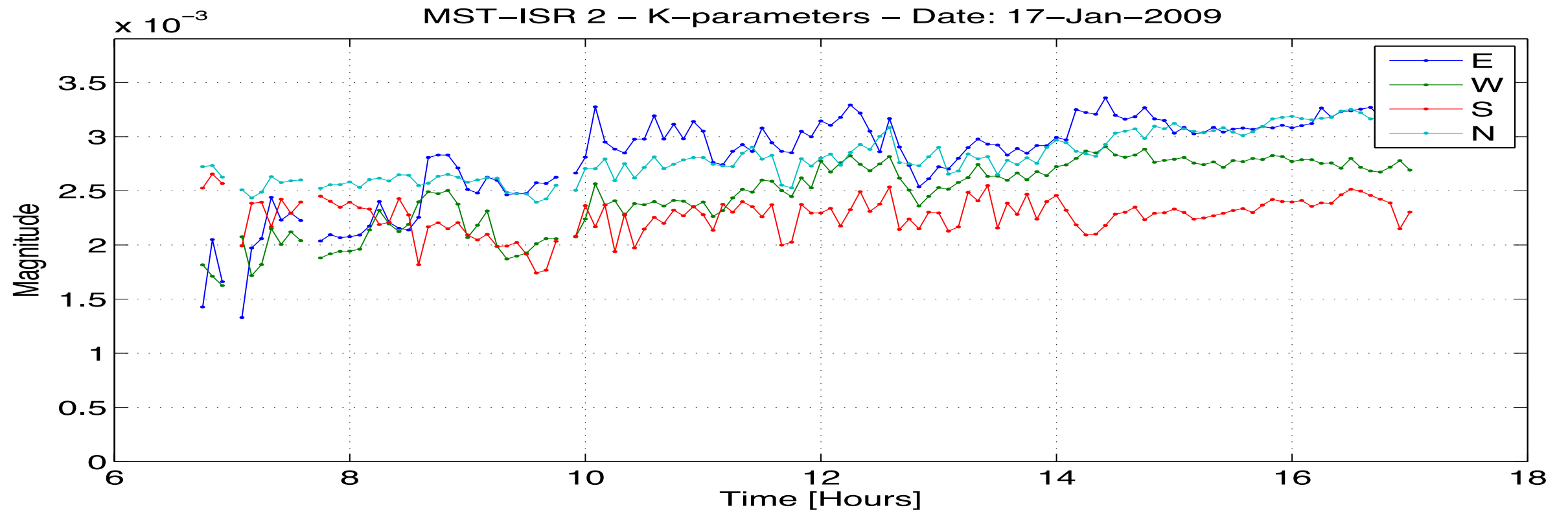



MST RCS – East Beam – Date: 27-Jan-2009

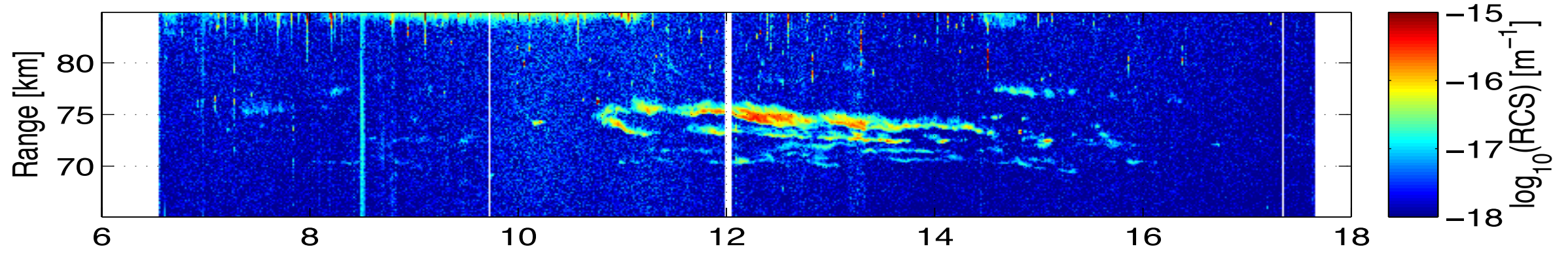

MST RCS – West Beam – Date: 27-Jan-2009

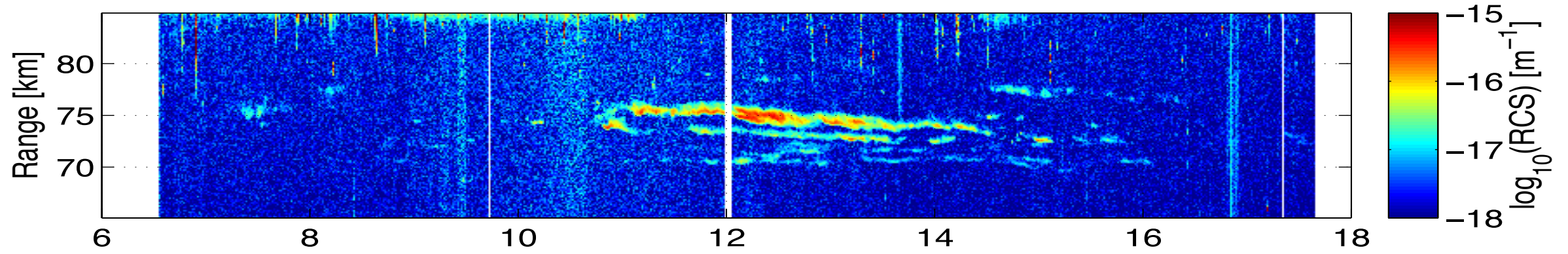

MST RCS – South Beam – Date: 27-Jan-2009

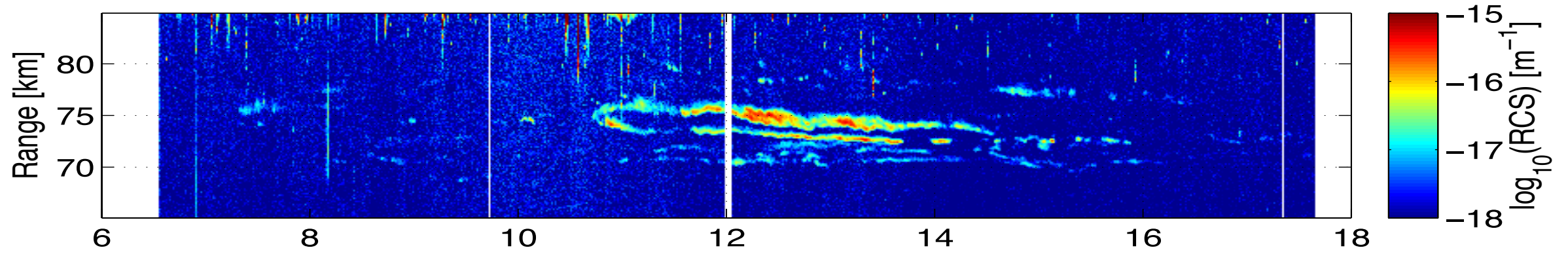

MST RCS – North Beam – Date: 27-Jan-2009

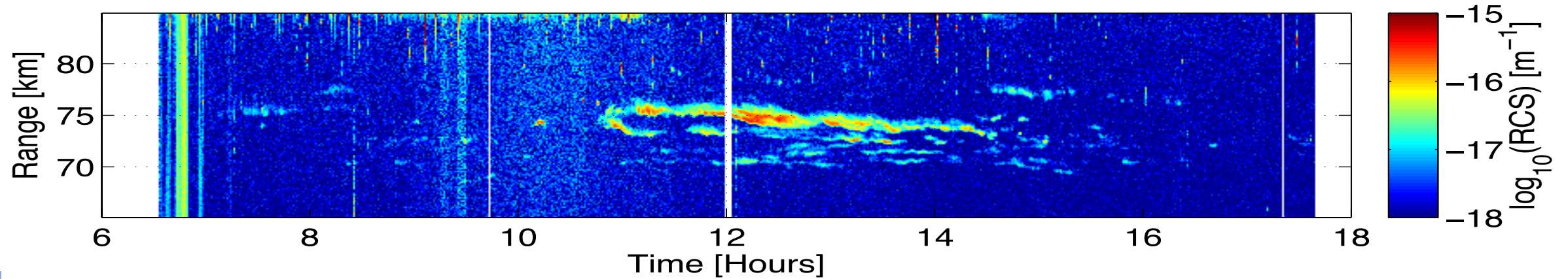



# Jan 2009 - North Beam RCS estimates:

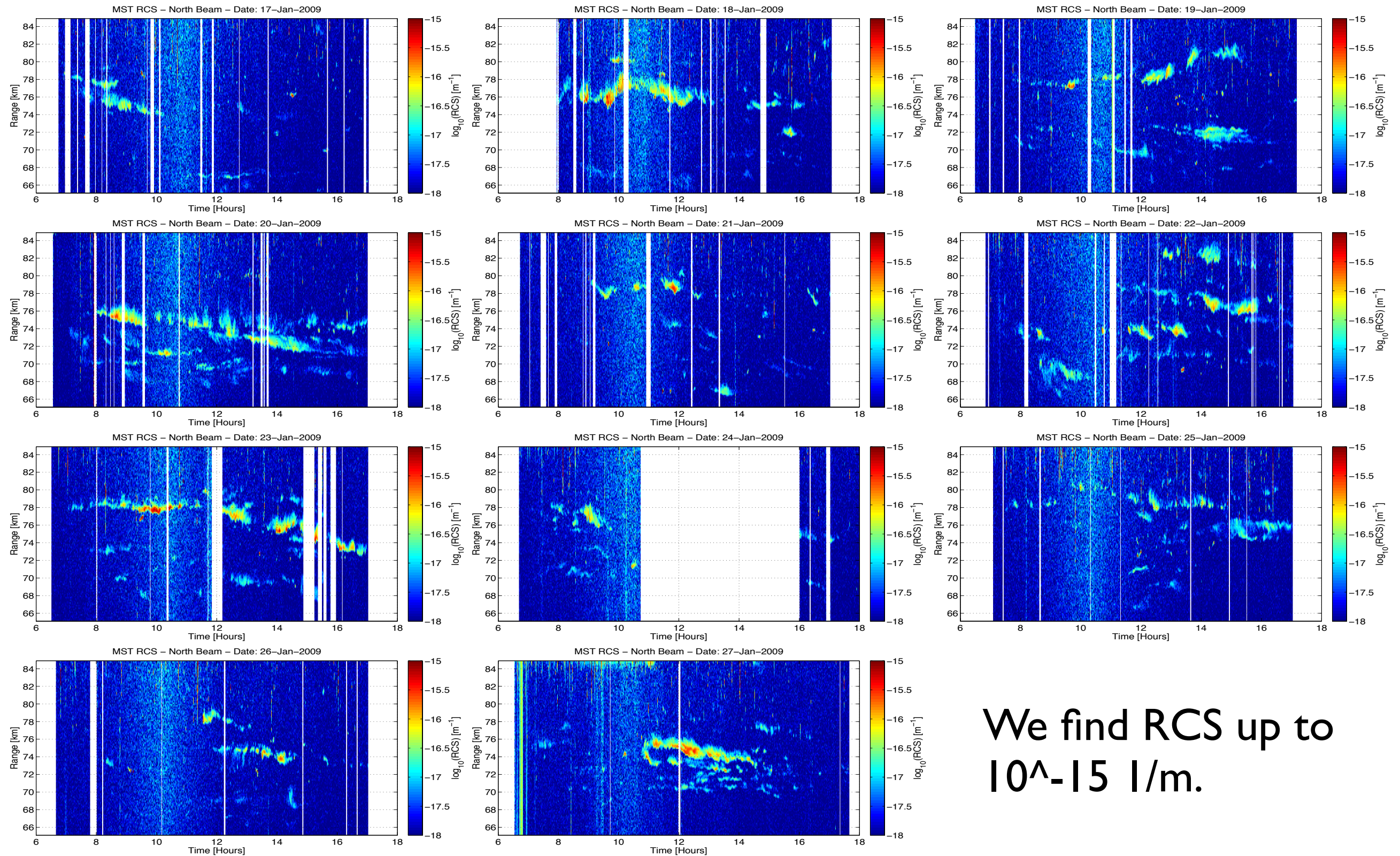

We find RCS up to  $10^{-15}$  I/m.



## Conclusions

- MST-ISR mode data collected with linearly polarized oblique antennas can be inverted for F-region electron densities,  $T_e/T_i$  ratios, and channel calibration constants.
- Ionosonde data provides density estimates in the E- and F1-regions and improves the accuracy of the estimates in the F2-region.
- Absolute cross-section measurements useful for beam-to beam and day to day comparisons.
- Multiple-layered vs sparsely layered “days” have been observed to have comparable RCS’s.
- Largest RCS’s observed in 70-75 km
- RCS’s up to 4 orders of magnitude stronger than D-region ISR (typically unobservable at JRO without MST contamination).





150-km RCS – East Beam – Date: 27-Jan-2009

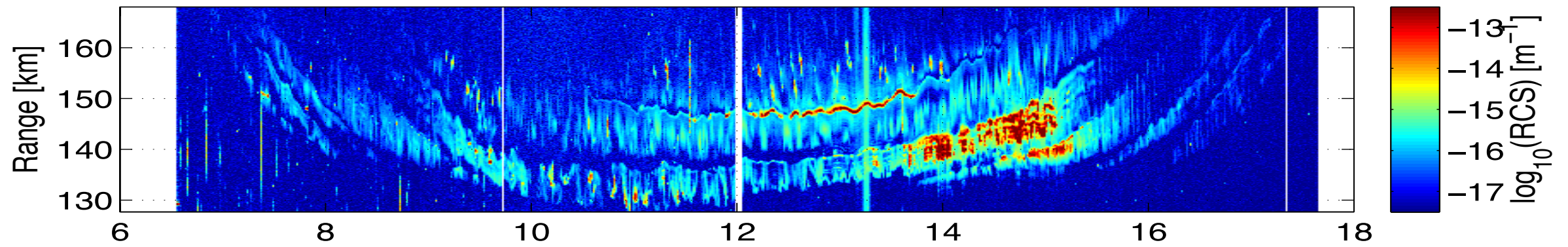

150-km RCS – West Beam – Date: 27-Jan-2009

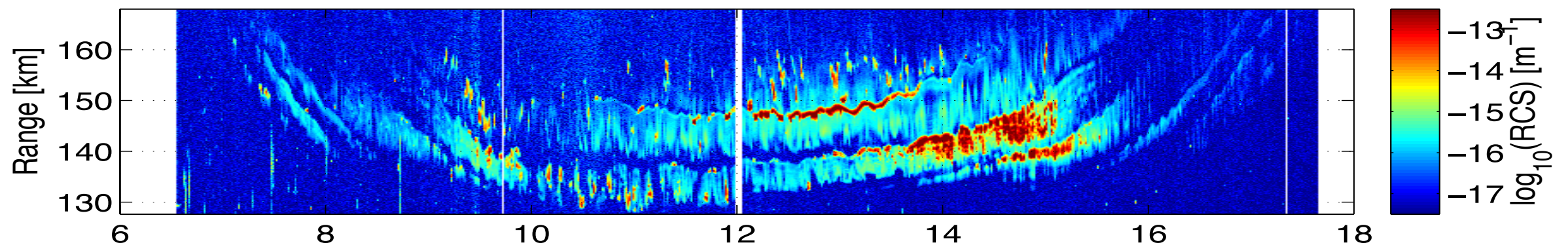

150-km RCS – South Beam – Date: 27-Jan-2009

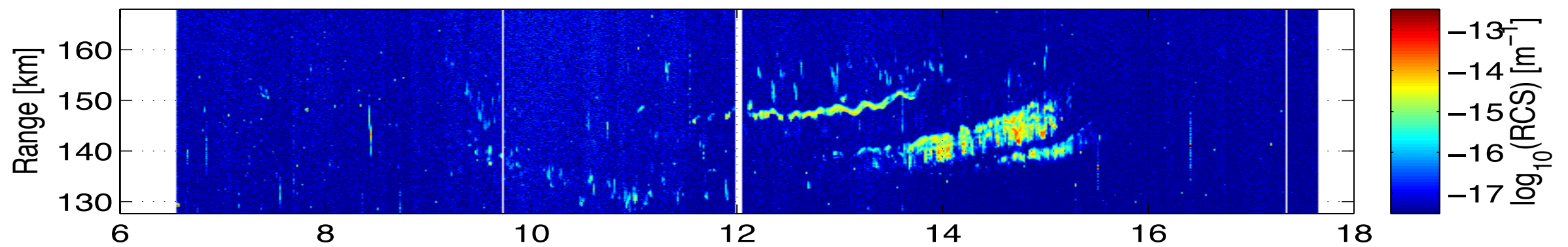

150-km RCS – North Beam – Date: 27-Jan-2009

